

OPTIDRIVE™

IP20 & IP66 (NEMA 4X)
AC Variable Speed Drive

0.37 – 11kW (0.5 – 15HP)
110 – 480V

Installation and Operating Instructions



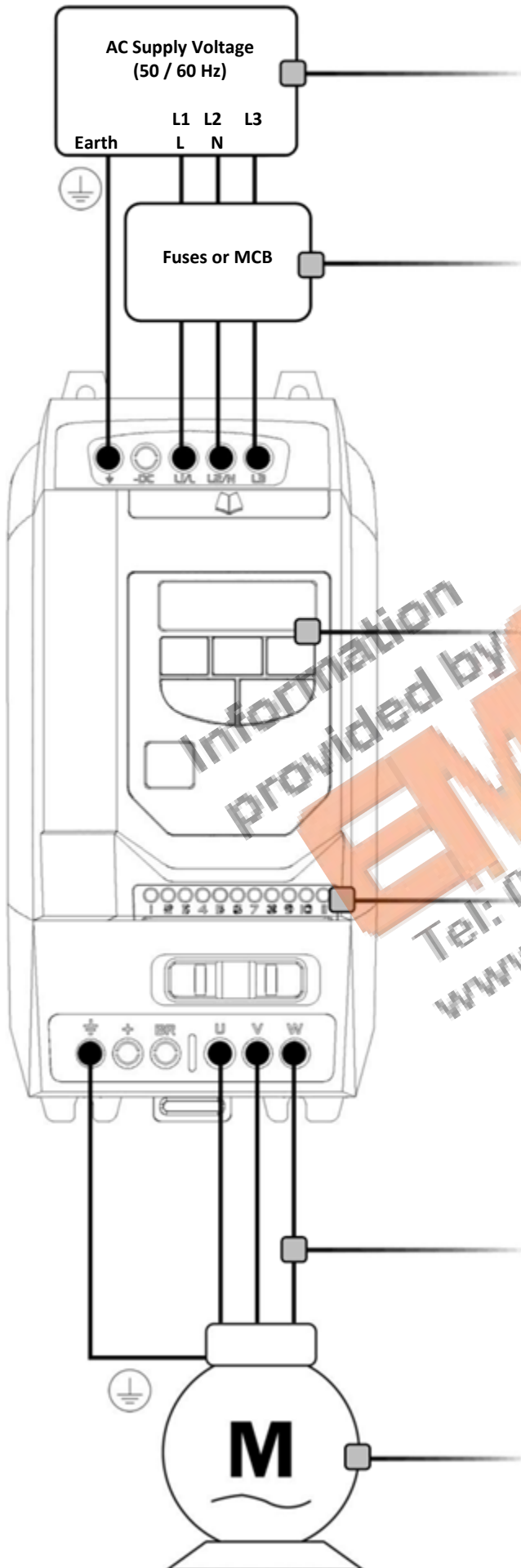

Supply Voltage

- 110 – 115, 200 – 240, 400 – 480 VAC + / - 10%
 - 1 or 3 Phase
- Check the drive rating information on page 26

Fuses or MCB

- Fuse Ratings given on page 26
- Recommended cable sizes shown on page 26

Mechanical Mounting

- Information can be found on page 10

Keypad operation can be found on page 16

Control Terminals

Based on the factory default (out of box) settings

- Connect a Start / Stop switch between terminals 1 & 2
- Close the switch to Start (Enable) the drive
- Open the switch to Stop (Disable) the drive
- Connect a potentiometer (5kΩ minimum) between terminals 5, 6 and 7 as shown below to vary the speed from minimum (0Hz) to maximum (50 / 60 Hz)

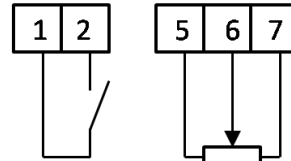

Motor Cable Information

- Check the rating information on page 26 for sizing information
- For EMC compliance, use a shielded type cable

Motor Connections

- Check for Star or Delta connection according to the motor nameplate and voltage rating (See page 13)

Motor Nameplate Details



Control Terminals

Based on the factory default (out of box) settings

- Connect a Start / Stop switch between terminals 1 & 2
- Close the switch to Start (Enable) the drive
- Open the switch to Stop (Disable) the drive
- Connect a potentiometer (5kΩ minimum) between terminals 5, 6 and 7 as shown below to vary the speed from minimum (0Hz) to maximum (50 / 60 Hz)

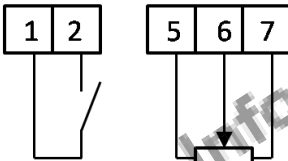

Mechanical Mounting

- Information can be found on page 10

Keypad operation can be found on page 16

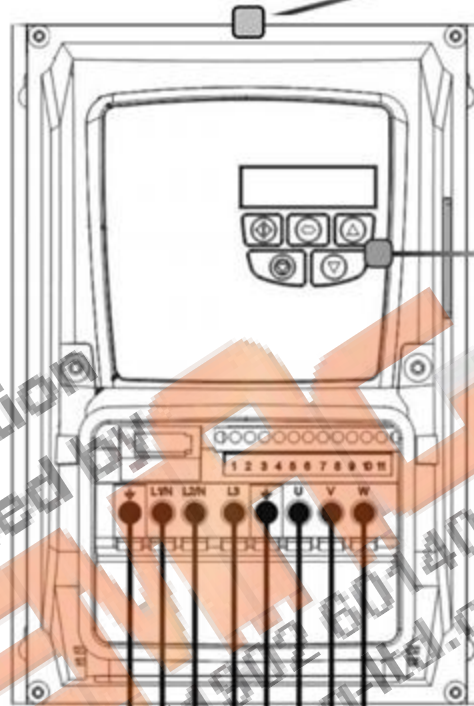

Fuses or MCB

- Fuse Ratings given on page 26
 - Recommended cable sizes shown on page 26
- Always follow local and national codes of practice

Motor Cable Information

- Check the rating information on page 26 for sizing information
- For EMC compliance, use a shielded type cable

Supply Voltage

- 110 – 115, 200 – 240, 400 – 480 VAC +/- 10%
 - 1 or 3 Phase
- Check the drive rating information on page 26

Motor Connections

- Check for Star or Delta connection according to the motor nameplate and voltage rating (See page 13)

Motor Nameplate Details

- Enter the motor rated voltage in P-07
- Enter the motor rated current in P-08
- Enter the motor rated frequency in P-09



Local Speed Potentiometer

The local speed potentiometer will adjust the output frequency from minimum (Parameter P-02, default setting = 0Hz) to maximum (Parameter P-01, default setting = 50 / 60 Hz)

Run Reverse / Off / Run Forward Switch

With the factory parameter settings, this switch allows the drive to be started in the forward and reverse operating directions. Alternative switch functions can be programmed, such as Local / Remote, Hand / Auto, see page 15

Mechanical Mounting

- Information can be found on page 10

Keypad operation can be found on page 16

Motor Cable Information

- Check the rating information on page 26 for sizing information
- For EMC compliance, use a shielded type cable

Motor Connections

- Check for Star or Delta connection according to the motor nameplate and voltage rating (See page 13)

Motor Nameplate Details

- Enter the motor rated voltage in P-07
- Enter the motor rated current in P-08
- Enter the motor rated frequency in P-09

Fuses or MCB

- Fuse Ratings given on page 26
 - Recommended cable sizes shown on page 26
- Always follow local and national codes of practice

Supply Voltage

- 110 – 115, 200 – 240, 400 – 480 VAC +/- 10%
 - 1 or 3 Phase
- Check the drive rating information on page 26

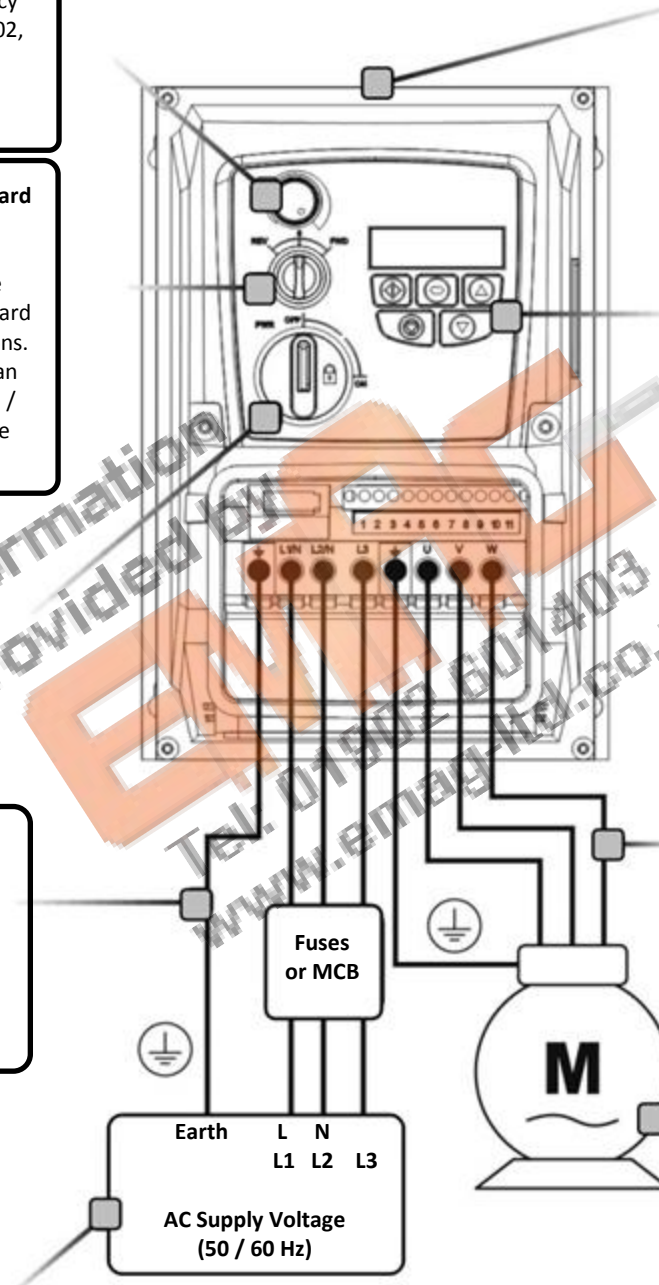

Information provided by
 Tel: 0191 607403
 www.emajtd.co.uk

Declaration of Conformity

Invertek Drives Ltd hereby states that the Optidrive ODE-2 product range conforms to the relevant safety provisions of the Low Voltage Directive 2006/95/EC and the EMC Directive 2004/108/EC and has been designed and manufactured in accordance with the following harmonised European standards:

EN 61800-5-1: 2003	Adjustable speed electrical power drive systems. Safety requirements. Electrical, thermal and energy.
EN 61800-3 2 nd Ed: 2004	Adjustable speed electrical power drive systems. EMC requirements and specific test methods
EN 55011: 2007	Limits and Methods of measurement of radio disturbance characteristics of industrial, scientific and medical (ISM) radio-frequency equipment (EMC)
EN60529 : 1992	Specifications for degrees of protection provided by enclosures

Electromagnetic Compatibility

All Optidrives are designed with high standards of EMC in mind. All versions suitable for operation on Single Phase 230 volt and Three Phase 400 volt supplies and intended for use within the European Union are fitted with an internal EMC filter. This EMC filter is designed to reduce the conducted emissions back into the supply via the power cables for compliance with the above harmonised European standards.

It is the responsibility of the installer to ensure that the equipment or system into which the product is incorporated complies with the EMC legislation of the country of use. Within the European Union, equipment into which this product is incorporated must comply with the EMC Directive 2004/108/EC. When using an Optidrive with an internal or optional external filter, compliance with the following EMC Categories, as defined by EN61800-3:2004 can be achieved:

Drive Type / Rating	EMC Category		
	Cat C1	Cat C2	Cat C3
1 Phase, 230 Volt Input ODE-2-x2xxx-1xBxx	No additional filtering required Use shielded motor cable		
3 Phase, 400 Volt Input ODE-2-x4xxx-3xAxx	Use External Filter OPT-2—E3xxxx Use shielded motor cable	No additional filtering required	
Note	Compliance with EMC standards is dependent on a number of factors including the environment in which the drive is installed, motor switching frequency, motor, cable lengths and installation methods adopted.		
	For shielded motor cable lengths greater than 100m and up to 200m, an output dv / dt filter must be used (please refer to the Invertek Stock Drives Catalogue for further details)		
	Compliance with EMC directives is achieved with the factory default parameter settings		

All rights reserved. No part of this User Guide may be reproduced or transmitted in any form or by any means, electrical or mechanical including photocopying, recording or by any information storage or retrieval system without permission in writing from the publisher.

Copyright Invertek Drives Ltd © 2013

All Invertek Optidrive units carry a 2 year warranty against manufacturing defects from the date of manufacture. The manufacturer accepts no liability for any damage caused during or resulting from transport, receipt of delivery, installation or commissioning. The manufacturer also accepts no liability for damage or consequences resulting from inappropriate, negligent or incorrect installation, incorrect adjustment of the operating parameters of the drive, incorrect matching of the drive to the motor, incorrect installation, unacceptable dust, moisture, corrosive substances, excessive vibration or ambient temperatures outside of the design specification.

The local distributor may offer different terms and conditions at their discretion, and in all cases concerning warranty, the local distributor should be contacted first.

This user guide is the “original instructions” document. All non-English versions are translations of the “original instructions”.

The contents of this User Guide are believed to be correct at the time of printing. In the interest of a commitment to a policy of continuous improvement, the manufacturer reserves the right to change the specification of the product or its performance or the contents of the User Guide without notice.

This User Guide is for use with version 1.10 Firmware.

User Guide Revision 3.10





Invertek Drives Ltd adopts a policy of continuous improvement and whilst every effort has been made to provide accurate and up to date information, the information contained in this User Guide should be used for guidance purposes only and does not form the part of any contract.

1. Introduction	7
1.1. <i>Important Safety Information</i>	7
2. General Information and Ratings	8
2.1. <i>Identifying the Drive by Model Number</i>	8
2.2. <i>Drive Model Numbers</i>	8
3. Mechanical Installation	9
3.1. <i>General</i>	9
3.2. <i>Before Installation</i>	9
3.3. <i>UL Compliant Installation</i>	9
3.4. <i>Mechanical Dimensions and Mounting – IP20 Open Units</i>	9
3.5. <i>Guidelines for Enclosure Mounting – IP20 Units</i>	9
3.6. <i>Mechanical Dimensions – IP66 (Nema 4X) Enclosed Units</i>	10
3.7. <i>Guidelines for mounting (IP66 Units)</i>	10
3.8. <i>Gland Plate and Lock Off</i>	11
3.9. <i>Removing the Terminal Cover</i>	11
3.10. <i>Routine Maintenance</i>	11
4. Power Wiring	12
4.1. <i>Grounding the Drive</i>	12
4.2. <i>Wiring Precautions</i>	12
4.3. <i>Incoming Power Connection</i>	13
4.4. <i>Drive and Motor Connection</i>	13
4.5. <i>Motor Terminal Box Connections</i>	13
4.6. <i>Motor Thermal overload Protection.</i>	14
4.7. <i>Control Terminal Wiring</i>	14
4.8. <i>Connection Diagram</i>	14
4.9. <i>Using the REV/O/FWD Selector Switch (Switched Version Only)</i>	15
4.10. <i>Control Terminal Connections</i>	15
5. Operation	16
5.1. <i>Managing the Keypad</i>	16
5.2. <i>Terminal Control</i>	16
5.3. <i>Keypad Control</i>	16
6. Parameters	17
6.1. <i>Standard Parameters</i>	17
6.2. <i>Extended Parameters</i>	18
6.3. <i>Adjusting the Voltage / Frequency (V/f) characteristics</i>	20
6.4. <i>P-00 Read Only Status Parameters</i>	21
7. Analog and Digital Input Configurations	22
7.1. <i>Terminal Mode (P-12 = 0)</i>	22
7.2. <i>Keypad Mode (P-12 = 1 or 2)</i>	23
7.3. <i>Modbus Control Mode (P-12 = 4)</i>	24
7.4. <i>User PI Control Mode</i>	24
7.5. <i>Motor Thermistor Connection</i>	24
8. Modbus RTU Communications	25
8.1. <i>Introduction</i>	25
8.2. <i>Modbus RTU Specification</i>	25
8.3. <i>RJ45 Connector Configuration</i>	25
8.4. <i>Modbus Telegram Structure</i>	25
8.5. <i>Modbus Register Map</i>	25
9. Technical Data	26
9.1. <i>Environmental</i>	26
9.2. <i>Rating Tables</i>	26
9.3. <i>Additional Information for UL Compliance</i>	27
10. Trouble Shooting	28
10.1. <i>Fault Code Messages</i>	28

1. Introduction

1.1. Important Safety Information

Please read the IMPORTANT SAFETY INFORMATION below, and all Warning and Caution information elsewhere.

	Danger : Indicates a risk of electric shock, which, if not avoided, could result in damage to the equipment and possible injury or death.		Danger : Indicates a potentially hazardous situation other than electrical, which if not avoided, could result in damage to property.
	<p>This variable speed drive product (Optidrive) is intended for professional incorporation into complete equipment or systems as part of a fixed installation. If installed incorrectly it may present a safety hazard. The Optidrive uses high voltages and currents, carries a high level of stored electrical energy, and is used to control mechanical plant that may cause injury. Close attention is required to system design and electrical installation to avoid hazards in either normal operation or in the event of equipment malfunction. Only qualified electricians are allowed to install and maintain this product.</p> <p>System design, installation, commissioning and maintenance must be carried out only by personnel who have the necessary training and experience. They must carefully read this safety information and the instructions in this Guide and follow all information regarding transport, storage, installation and use of the Optidrive, including the specified environmental limitations.</p> <p>Do not perform any flash test or voltage withstand test on the Optidrive. Any electrical measurements required should be carried out with the Optidrive disconnected.</p> <p>Electric shock hazard! Disconnect and ISOLATE the Optidrive before attempting any work on it. High voltages are present at the terminals and within the drive for up to 10 minutes after disconnection of the electrical supply. Always ensure by using a suitable multimeter that no voltage is present on any drive power terminals prior to commencing any work.</p> <p>Where supply to the drive is through a plug and socket connector, do not disconnect until 10 minutes have elapsed after turning off the supply.</p> <p>Ensure correct earthing connections. The earth cable must be sufficient to carry the maximum supply fault current which normally will be limited by the fuses or MCB. Suitably rated fuses or MCB should be fitted in the mains supply to the drive, according to any local legislation or codes.</p> <p>Ensure correct earthing connections and cable selection as per defined by local legislation or codes. The drive may have a leakage current of greater than 3.5mA; furthermore the earth cable must be sufficient to carry the maximum supply fault current which normally will be limited by the fuses or MCB. Suitably rated fuses or MCB should be fitted in the mains supply to the drive, according to any local legislation or codes.</p> <p>Do not carry out any work on the drive control cables whilst power is applied to the drive or to the external control circuits.</p>		
	<p>Within the European Union, all machinery in which this product is used must comply with Directive 98/37/EC, Safety of Machinery. In particular, the machine manufacturer is responsible for providing a main switch and ensuring the electrical equipment complies with EN60204-1.</p> <p>The level of integrity offered by the Optidrive control input functions – for example stop/start, forward/reverse and maximum speed is not sufficient for use in safety-critical applications without independent channels of protection. All applications where malfunction could cause injury or loss of life must be subject to a risk assessment and further protection provided where needed.</p> <p>The driven motor can start at power up if the enable input signal is present.</p> <p>The STOP function does not remove potentially lethal high voltages. ISOLATE the drive and wait 10 minutes before starting any work on it. Never carry out any work on the Drive, Motor or Motor cable whilst the input power is still applied.</p> <p>The Optidrive can be programmed to operate the driven motor at speeds above or below the speed achieved when connecting the motor directly to the mains supply. Obtain confirmation from the manufacturers of the motor and the driven machine about suitability for operation over the intended speed range prior to machine start up.</p> <p>Do not activate the automatic fault reset function on any systems whereby this may cause a potentially dangerous situation.</p> <p>IP66 drives provide their own pollution degree 2 environments. IP20 drives must be installed in a pollution degree 2 environment, mounted in a cabinet with IP54 or better.</p> <p>Optidrives are intended for indoor use only.</p> <p>When mounting the drive, ensure that sufficient cooling is provided. Do not carry out drilling operations with the drive in place, dust and swarf from drilling may lead to damage.</p> <p>The entry of conductive or flammable foreign bodies should be prevented. Flammable material should not be placed close to the drive</p> <p>Relative humidity must be less than 95% (non-condensing).</p> <p>Ensure that the supply voltage, frequency and no. of phases (1 or 3 phase) correspond to the rating of the Optidrive as delivered.</p> <p>Never connect the mains power supply to the Output terminals U, V, W.</p> <p>Do not install any type of automatic switchgear between the drive and the motor</p> <p>Wherever control cabling is close to power cabling, maintain a minimum separation of 100 mm and arrange crossings at 90 degrees</p> <p>Ensure that all terminals are tightened to the appropriate torque setting</p> <p>Do not attempt to carry out any repair of the Optidrive. In the case of suspected fault or malfunction, contact your local Invertek Drives Sales Partner for further assistance.</p>		

3. Mechanical Installation

3.1. General

- The Optidrive should be mounted in a vertical position only, on a flat, flame resistant, vibration free mounting using the integral mounting holes or DIN Rail clip (Frame Sizes 1 and 2 only).
- The Optidrive must be installed in a pollution degree 1 or 2 environment only.
- Do not mount flammable material close to the Optidrive
- Ensure that the minimum cooling air gaps, as detailed in section 3.5 and 3.7 are left clear
- Ensure that the ambient temperature range does not exceed the permissible limits for the Optidrive given in section 9.1
- Provide suitable clean, moisture and contaminant free cooling air sufficient to fulfil the cooling requirements of the Optidrive

3.2. Before Installation

- Carefully Unpack the Optidrive and check for any signs of damage. Notify the shipper immediately if any exist.
- Check the drive rating label to ensure it is of the correct type and power requirements for the application.
- To prevent accidental damage always store the Optidrive in its original box until required. Storage should be clean and dry and within the temperature range -40°C to +60°C

3.3. UL Compliant Installation

Refer to section 9.3 on page 27 for Additional Information for UL Compliance.

3.4. Mechanical Dimensions and Mounting – IP20 Open Units

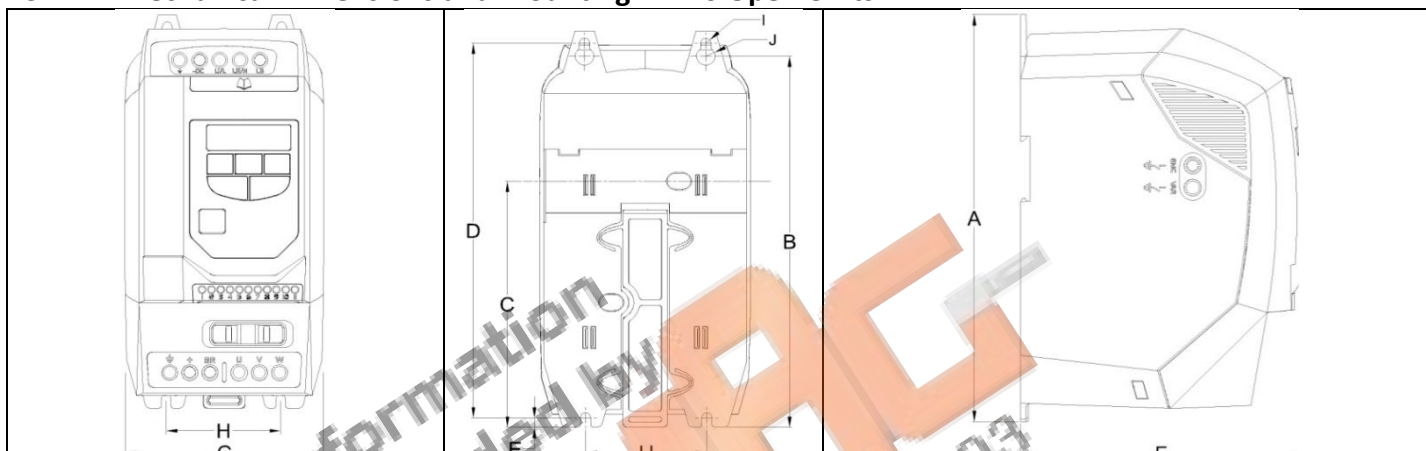

Drive Size	A		B		C		D		E		F		G		H		I		J		Weight	
	mm	in	mm	in	mm	in	mm	in	mm	in	mm	in	mm	in	mm	in	mm	in	mm	in	Kg	lb
1	173	6.81	160	6.30	109	4.29	162	6.38	5	0.20	123	4.84	82	3.23	50	1.97	5.5	0.22	10	0.39	1	2.2
2	221	8.70	207	8.15	137	5.39	209	8.23	5.3	0.21	150	5.91	109	4.29	63	2.48	5.5	0.22	10	0.39	1.7	3.8
3	261	10.28	246	9.69	-	-	247	9.72	6	0.24	175	6.89	131	5.16	80	3.15	5.5	0.22	10	0.39	3.2	7.1
Mounting Bolts					All Frame Sizes					4 x M4 (#8)												
Tightening Torques					All Frame Sizes					Control Terminals					0.5 Nm (4.5 lb-in)							
										Power Terminals					1 Nm (8.85 lb-in)							

3.5. Guidelines for Enclosure Mounting – IP20 Units

- IP20 drives are suitable for use in pollution degree 1 environments, according to IEC-664-1. For pollution degree 2 or higher environments, drives should be mounted in a suitable control cabinet with sufficient ingress protection to maintain a pollution degree 1 environment around the drive.
- Enclosures should be made from a thermally conductive material.
- Ensure the minimum air gap clearances around the drive as shown below are observed when mounting the drive.
- Where ventilated enclosures are used, there should be venting above the drive and below the drive to ensure good air circulation. Air should be drawn in below the drive and expelled above the drive.
- In any environments where the conditions require it, the enclosure must be designed to protect the Optidrive against ingress of airborne dust, corrosive gases or liquids, conductive contaminants (such as condensation, carbon dust, and metallic particles) and sprays or splashing water from all directions.
- High moisture, salt or chemical content environments should use a suitably sealed (non-vented) enclosure.

The enclosure design and layout should ensure that the adequate ventilation paths and clearances are left to allow air to circulate through the drive heatsink. Inverterk Drives recommend the following minimum sizes for drives mounted in non-ventilated metallic enclosures:-

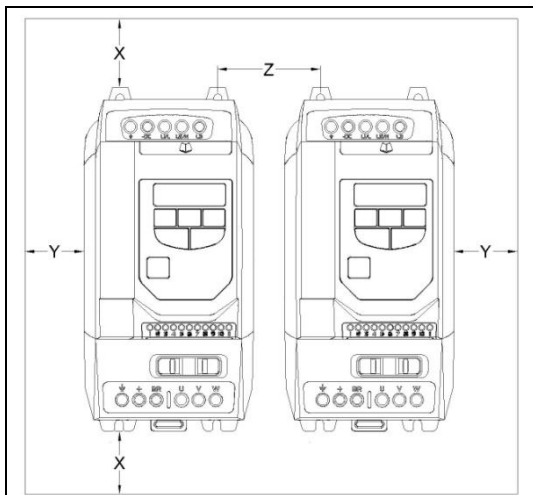

Drive Size	X Above & Below		Y Either Side		Z Between		Recommended airflow CFM (ft ³ /min)
	mm	in	mm	in	mm	in	
1	50	1.97	50	1.97	33	1.30	11
2	75	2.95	50	1.97	46	1.81	11
3	100	3.94	50	1.97	52	2.05	26

Note :
 Dimension Z assumes that the drives are mounted side-by-side with no clearance.
 Typical drive heat losses are 3% of operating load conditions.
 Above are guidelines only and the operating ambient temperature of the drive MUST be maintained at all times.

3.6. Mechanical Dimensions – IP66 (Nema 4X) Enclosed Units

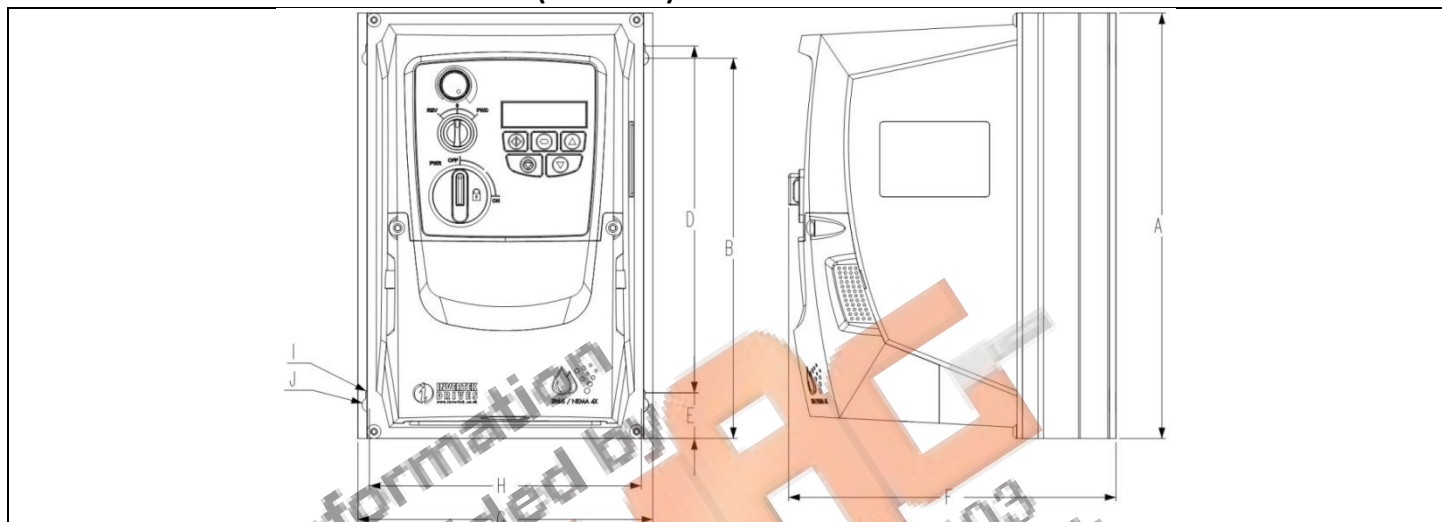

Drive Size	A		B		D		E		F		G		H		I		J		Weight	
	mm	in	mm	in	mm	in	mm	in	mm	in	mm	in	mm	in	mm	in	mm	in	kg	lb
1	232.0	9.13	207.0	8.15	189.0	7.44	25.0	0.98	179.0	7.05	161.0	6.34	148.5	5.85	4.0	0.16	8.0	0.31	3	6.6
2	257.0	10.12	220.0	8.67	200.0	7.87	28.5	1.12	186.5	7.34	188.0	7.40	176.0	6.93	4.2	0.17	8.5	0.33	4.2	9.3
3	310.0	12.20	276.5	10.89	251.5	9.90	33.4	1.31	228.7	9.00	210.5	8.29	197.5	7.78	4.2	0.17	8.5	0.33	7.7	17

Mounting Bolts	All Frame Sizes	4 x M4 (#8)	
Tightening Torques	All Frame Sizes	Control Terminals	0.5 Nm (4.5 lb-in)
		Power Terminals	1 Nm (8.85 lb-in)

3.7. Guidelines for mounting (IP66 Units)

- Before mounting the drive, ensure that the chosen location meets the environmental condition requirements for the drive shown in section 9.1
- The drive must be mounted vertically, on a suitable flat surface
- The minimum mounting clearances as shown in the table below must be observed
- The mounting site and chosen mountings should be sufficient to support the weight of the drives

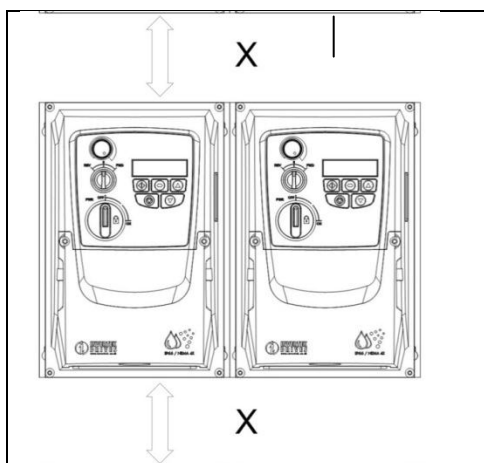

Drive Size	X Above & Below		Y Either Side	
	mm	in	mm	in
2	200	7.87	10	0.39
3	200	7.87	10	0.39

Note :
 Typical drive heat losses are approximately 3% of operating load conditions.
 Above are guidelines only and the operating ambient temperature of the drive MUST be maintained at all times.

Cable Gland Sizes			
Frame	Power Cable	Motor Cable	Control Cables
2	M25 (PG21)	M25 (PG21)	M20 (PG13.5)
3	M25 (PG21)	M25 (PG21)	M20 (PG13.5)

- Using the drive as a template, or the dimensions shown above, mark the locations required for drilling
- Suitable cable glands to maintain the ingress protection of the drive are required. Gland holes for power and motor cables are pre-moulded into the drive enclosure, recommended gland sizes are shown above. Gland holes for control cables may be cut as required.

3.8. Gland Plate and Lock Off

The use of a suitable gland system is required to maintain the appropriate IP / Nema rating. The gland plate has pre moulded cable entry holes for power and motor connections suitable for use with glands as shown in the following table. Where additional holes are required, these can be drilled to suitable size. Please take care when drilling to avoid leaving any particles within the product.

Cable Gland recommended Hole Sizes & types:						
	Power & Motor Cables			Control & Signal Cables		
	Moulded Hole Size	Imperial Gland	Metric Gland	Knockout Size	Imperial Gland	Metric Gland
Size 1	22mm	PG13.5	M20	22mm	PG13.5	M20
Size 2 & 3	27mm	PG21	M25	22mm	PG13.5	M20

Flexible Conduit Hole Sizes:			
	Drill Size	Trade Size	Metric
Size 1	28mm	¾ in	21
Size 2 & 3	35mm	1 in	27

- UL rated ingress protection ("Type ") is only met when cables are installed using a UL recognized bushing or fitting for a flexible-conduit system which meets the required level of protection ("Type")
- For conduit installations the conduit entry holes require standard opening to the required sizes specified per the NEC
- Not intended for rigid conduit system

Power Isolator Lock Off

On the switched models the main power isolator switch can be locked in the 'Off' position using a 20mm standard shackle padlock (not supplied).

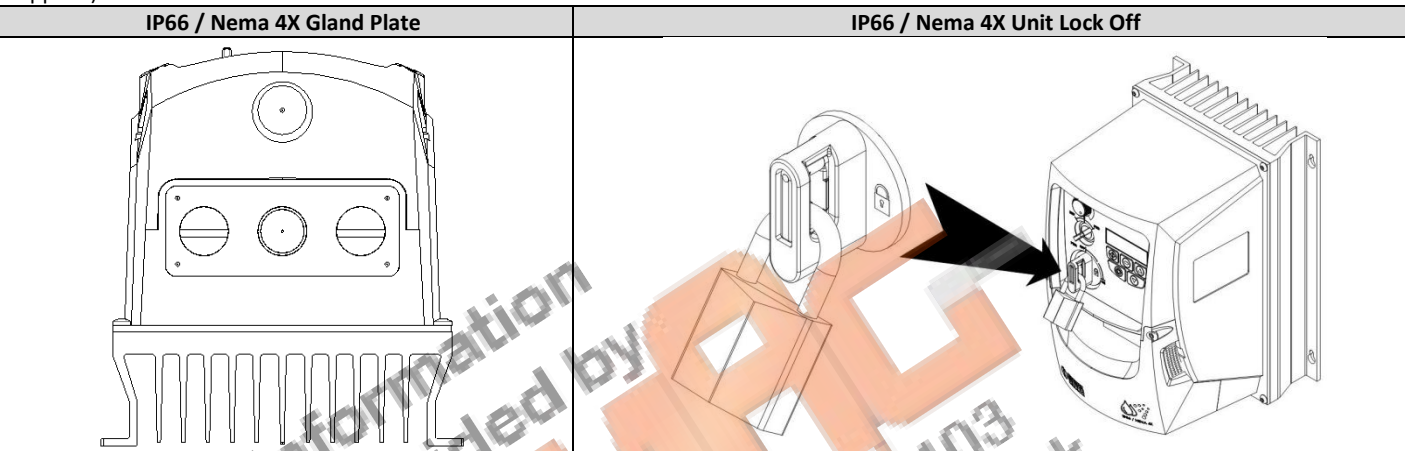

3.9. Removing the Terminal Cover

To access the connection terminals, the drive front cover needs to be removed as shown.

IP66 / Nema 4X Units
Removing the 2 screws on the front of the product allows access to the connection terminals, as shown below.

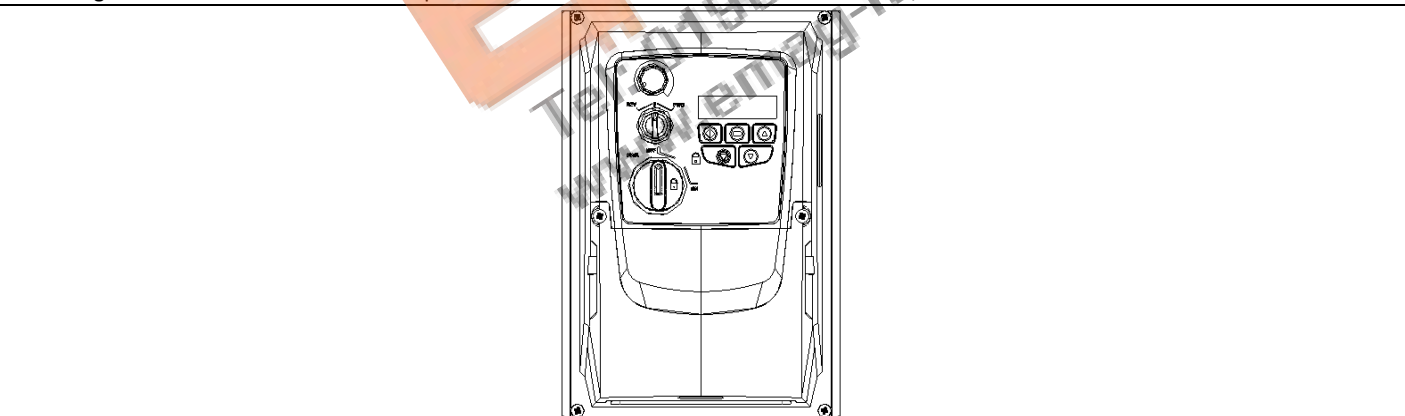

3.10. Routine Maintenance

The drive should be included within the scheduled maintenance program so that the installation maintains a suitable operating environment, this should include:

- Ambient temperature is at or below that set out in the "Environment" section.
- Heat sink fans freely rotating and dust free.
- The Enclosure in which the drive is installed should be free from dust and condensation; furthermore ventilation fans and air filters should be checked for correct air flow.

Checks should also be made on all electrical connections, ensuring screw terminals are correctly torqued; and that power cables have no signs of heat damage.

4. Power Wiring

4.1. Grounding the Drive



This manual is intended as a guide for proper installation. Invertek Drives Ltd cannot assume responsibility for the compliance or the non-compliance to any code, national, local or otherwise, for the proper installation of this drive or associated equipment. A hazard of personal injury and/or equipment damage exists if codes are ignored during installation.



This Optidrive contains high voltage capacitors that take time to discharge after removal of the main supply. Before working on the drive, ensure isolation of the main supply from line inputs. Wait ten (10) minutes for the capacitors to discharge to safe voltage levels. Failure to observe this precaution could result in severe bodily injury or loss of life.



Only qualified electrical personnel familiar with the construction and operation of this equipment and the hazards involved should install, adjust, operate, or service this equipment. Read and understand this manual and other applicable manuals in their entirety before proceeding. Failure to observe this precaution could result in severe bodily injury or loss of life.

Grounding Guidelines

The ground terminal of each Optidrive should be individually connected DIRECTLY to the site ground bus bar (through the filter if installed). Optidrive ground connections should not loop from one drive to another, or to, or from any other equipment. Ground loop impedance must conform to local industrial safety regulations. To meet UL regulations, UL approved ring crimp terminals should be used for all ground wiring connections.

The drive Safety Ground must be connected to system ground. Ground impedance must conform to the requirements of national and local industrial safety regulations and/or electrical codes. The integrity of all ground connections should be checked periodically.

Protective Earth Conductor

The Cross sectional area of the PE Conductor must be at least equal to that of the incoming supply conductor.

Safety Ground

This is the safety ground for the drive that is required by code. One of these points must be connected to adjacent building steel (girder, joist), a floor ground rod, or bus bar. Grounding points must comply with national and local industrial safety regulations and/or electrical codes.

Motor Ground

The motor ground must be connected to one of the ground terminals on the drive.

Ground Fault Monitoring

As with all inverters, a leakage current to earth can exist. The Optidrive is designed to produce the minimum possible leakage current whilst complying with worldwide standards. The level of current is affected by motor cable length and type, the effective switching frequency, the earth connections used and the type of RFI filter installed. If an ELCB (Earth Leakage Circuit Breaker) is to be used, the following conditions apply: -

- A Type B Device must be used
- The device must be suitable for protecting equipment with a DC component in the leakage current
- Individual ELCBs should be used for each Optidrive

Drives with an EMC filter have an inherently higher leakage current to Ground (Earth). For applications where tripping occurs the EMC filter can be disconnected (on IP20 units only) by removing the EMC screw on the side of the product.

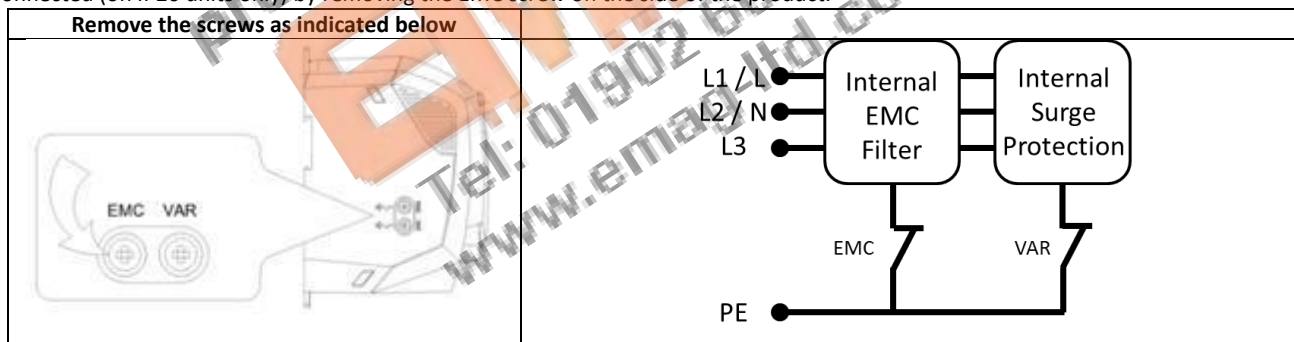

The Optidrive product range has input supply voltage surge suppression components fitted to protect the drive from line voltage transients, typically originating from lightning strikes or switching of high power equipment on the same supply.

When carrying out a HiPot (Flash) test on an installation in which the drive is built, the voltage surge suppression components may cause the test to fail. To accommodate this type of system HiPot test, the voltage surge suppression components can be disconnected by removing the VAR screw. After completing the HiPot test, the screw should be replaced and the HiPot test repeated. The test should then fail, indicating that the voltage surge suppression components are once again in circuit.

Shield Termination (Cable Screen)

The safety ground terminal provides a grounding point for the motor cable shield. The motor cable shield connected to this terminal (drive end) should also be connected to the motor frame (motor end). Use a shield terminating or EMI clamp to connect the shield to the safety ground terminal.

4.2. Wiring Precautions

Connect the Optidrive according to sections 4.8.1 and 4.8.2, ensuring that motor terminal box connections are correct. There are two connections in general: Star and Delta. It is essential to ensure that the motor is connected in accordance with the voltage at which it will be operated. For more information, refer to section 4.5 Motor Terminal Box Connections.

It is recommended that the power cabling should be 4-core PVC-insulated screened cable, laid in accordance with local industrial regulations and codes of practice.

4.3. Incoming Power Connection

- For 1 phase supply, power should be connected to L1/L, L2/N.
- For 3 phase supplies, power should be connected to L1, L2, and L3. Phase sequence is not important.
- For compliance with CE and C Tick EMC requirements, a symmetrical shielded cable is recommended.
- A fixed installation is required according to IEC61800-5-1 with a suitable disconnecting device installed between the Optidrive and the AC Power Source. The disconnecting device must conform to the local safety code / regulations (e.g. within Europe, EN60204-1, Safety of machinery).
- The cables should be dimensioned according to any local codes or regulations. Guideline dimensions are given in section 9.2.
- Suitable fuses to provide wiring protection of the input power cable should be installed in the incoming supply line, according to the data in section 9.2. The fuses must comply with any local codes or regulations in place. In general, type gG (IEC 60269) or UL type T fuses are suitable; however in some cases type aR fuses may be required. The operating time of the fuses must be below 0.5 seconds.
- Where allowed by local regulations, suitably dimensioned type B MCB circuit breakers of equivalent rating may be utilised in place of fuses, providing that the clearing capacity is sufficient for the installation.
- When the power supply is removed from the drive, a minimum of 30 seconds should be allowed before re-applying the power. A minimum of 5 minutes should be allowed before removing the terminal covers or connection.
- The maximum permissible short circuit current at the Optidrive Power terminals as defined in IEC60439-1 is 100kA.
- An optional Input Choke is recommended to be installed in the supply line for drives where any of the following conditions occur:-
 - The incoming supply impedance is low or the fault level / short circuit current is high
 - The supply is prone to dips or brown outs
 - An imbalance exists on the supply (3 phase drives)
 - The power supply to the drive is via a busbar and brush gear system (typically overhead Cranes).
- In all other installations, an input choke is recommended to ensure protection of the drive against power supply faults. Part numbers are shown in the table.

Supply	Frame Size	AC Input Inductor
230 Volt 1 Phase	1	OPT-2-L1016-20
	2	OPT-2-L1025-20
	3	N/A
400 Volt 3 Phase	2	OPT-2-L3006-20
	2	OPT-2-L3010-20
	3	OPT-2-L3036-20

4.4. Drive and Motor Connection

- The drive inherently produces fast switching of the output voltage (PWM) to the motor compared to the mains supply, for motors which have been wound for operation with a variable speed drive then there is no preventative measures required, however if the quality of insulation is unknown then the motor manufacturer should be consulted and preventative measures may be required.
- The motor should be connected to the Optidrive U, V, and W terminals using a suitable 3 or 4 core cable. Where a 3 core cable is utilised, with the shield operating as an earth conductor, the shield must have a cross sectional area at least equal to the phase conductors when they are made from the same material. Where a 4 core cable is utilised, the earth conductor must be of at least equal cross sectional area and manufactured from the same material as the phase conductors.
- The motor earth must be connected to one of the Optidrive earth terminals.
- For compliance with the European EMC directive, a suitable screened (shielded) cable should be used. Braided or twisted type screened cable where the screen covers at least 85% of the cable surface area, designed with low impedance to HF signals are recommended as a minimum. Installation within a suitable steel or copper tube is generally also acceptable.
- The cable screen should be terminated at the motor end using an EMC type gland allowing connection to the motor body through the largest possible surface area
- Where drives are mounted in a steel control panel enclosure, the cable screen may be terminated directly to the control panel using a suitable EMC clamp or gland, as close to the drive as possible.
- For IP66 drives, connect the motor cable screen to the internal ground clamp

4.5. Motor Terminal Box Connections

Most general purpose motors are wound for operation on dual voltage supplies. This is indicated on the nameplate of the motor. This operational voltage is normally selected when installing the motor by selecting either STAR or DELTA connection. STAR always gives the higher of the two voltage ratings.

Incoming Supply Voltage	Motor Nameplate Voltages		Connection
230	230 / 400	Delta	
400	400 / 690		
400	230 / 400	Star	

4.6. Motor Thermal overload Protection.

4.6.1. Internal Thermal Overload Protection.

The drive has an in-built motor thermal overload function; this is in the form of an "I.t-trP" trip after delivering >100% of the value set in P-08 for a sustained period of time (e.g. 150% for 60 seconds).

4.6.2. Motor Thermistor Connection

Where a motor thermistor is to be used, it should be connected as follows :-

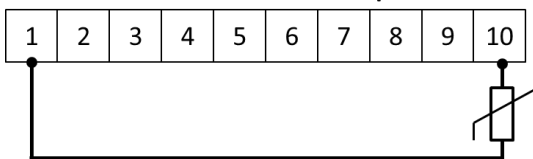
<p>Control Terminal Strip</p> 	<p>Additional Information</p> <ul style="list-style-type: none"> • Compatible Thermistor : PTC Type, 2.5kΩ trip level • Use a setting of P-15 that has Input 3 function as External Trip, e.g. P-15 = 3. Refer to section 7 for further details.
------------------------------------------------------------------------------------------------------------------------	---------------------------------------------------------------------------------------------------------------------------------------------------------------------------------------------------------------------------------------------------------------------------------

4.7. Control Terminal Wiring

- All analog signal cables should be suitably shielded. Twisted pair cables are recommended.
- Power and Control Signal cables should be routed separately where possible, and must not be routed parallel to each other.
- Signal levels of different voltages e.g. 24 Volt DC and 110 Volt AC, should not be routed in the same cable.
- Maximum control terminal tightening torque is 0.5Nm.
- Control Cable entry conductor size: 0.05 – 2.5mm² / 30 – 12 AWG.

4.8. Connection Diagram

4.8.1. IP66 (Nema 4X) Switched Units

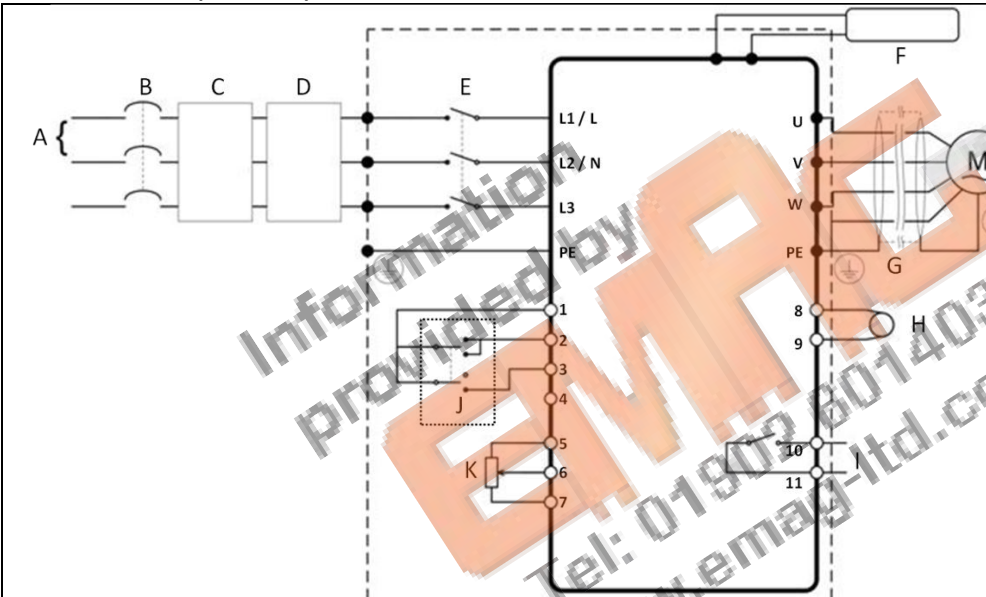

Power Connections	
A	Incoming Power Supply
B	External MCB or Fuse
C	Optional Input Choke
D	Optional Input Filter
E	Internal Isolator / Disconnect
F	Optional Brake Resistor
G	Shielded Motor Cable
I	Relay Output
Control Connections	
J	Internal Forward / Off / Reverse Switch
K	Internal Speed Control Pot

8	Analog Output 0 – 10 Volts
9	0 Volt
10	Relay Output
11	'Drive Healthy' = Closed

4.8.2. IP20 & IP66 (Nema 4X) Non- Switched Units

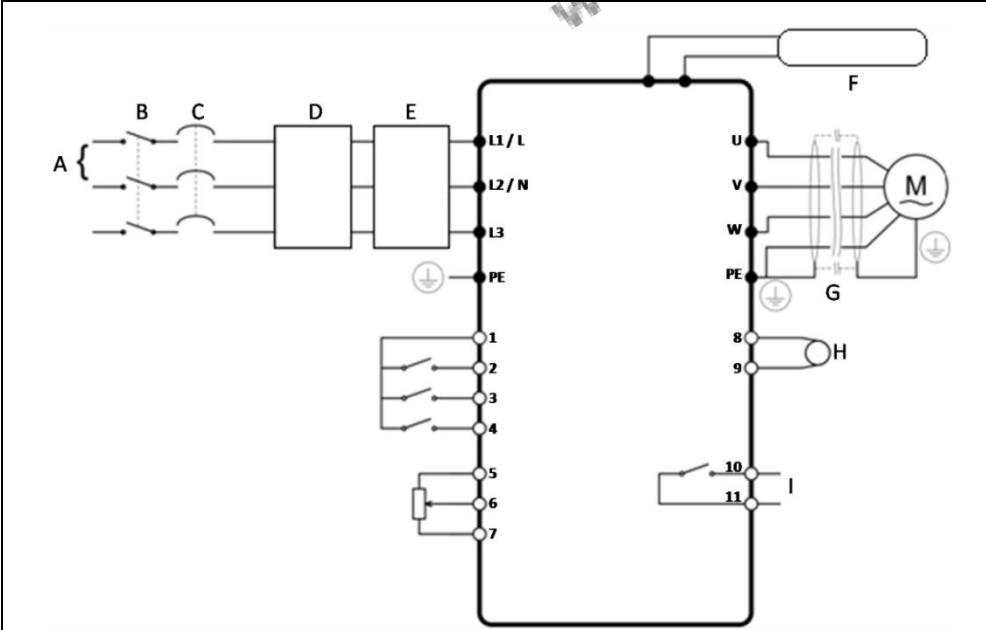

Power Connections	
A	Incoming Power Supply
B	Isolator / Disconnect
C	MCB or Fuse
D	Optional Input Choke
E	Optional Input Filter
F	Optional Brake Resistor
G	Shielded Motor Cable
I	Relay Output
Control Connections	
1	+ 24 Volt (100mA) User Output
2	Digital Input 1 Drive Run / Stop
3	Digital Input 2 Forward / Reverse
4	Digital Input 3 Analog / Preset Speed
5	+ 10 Volt Output
6	Analog Input 1
7	0 Volt
8	Analog Output 0 – 10 Volts
9	0 Volt
10	Relay Output
11	'Drive Healthy' = Closed

4.9. Using the REV/0/FWD Selector Switch (Switched Version Only)

By adjusting the parameter settings the Optidrive can be configured for multiple applications and not just for Forward or Reverse. This could typically be for Hand/Off/Auto applications (also known as Local/Remote) for HVAC and pumping industries.

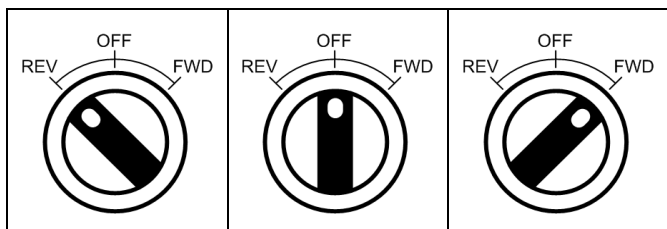

Switch Position			Parameters to Set		Notes
			P-12	P-15	
Run Reverse	STOP	Run Forward	0	0	Factory Default Configuration Run Forward or Reverse with speed controlled from the Local POT
STOP	STOP	Run Forward	0	5,7	Run forward with speed controlled from the local POT Run Reverse - disabled
Preset Speed 1	STOP	Run Forward	0	1	Run Forward with speed controlled from the Local POT Preset Speed 1 provides a 'Jog' Speed set in P-20
Run Reverse	STOP	Run Forward	0	6, 8	Run Forward or Reverse with speed controlled from the Local POT
Run in Auto	STOP	Run in Hand	0	4	Run in Hand – Speed controlled from the Local POT Run in Auto 0 Speed controlled using Analog input 2 e.g. from PLC with 4-20mA signal.
Run in Speed Control	STOP	Run in PI Control	5	1	In Speed Control the speed is controlled from the Local POT In PI Control, Local POT controls PI set point
Run in Preset Speed Control	STOP	Run in PI Control	5	0, 2, 4,5, 8..12	In Preset Speed Control, P-20 sets the Preset Speed In PI Control, POT can control the PI set point (P-44=1)
Run in Hand	STOP	Run in Auto	3	6	Hand – speed controlled from the Local POT Auto – Speed Reference from Modbus
Run in Hand	STOP	Run in Auto	3	3	Hand – Speed reference from Preset Speed 1 (P-20) Auto – Speed Reference from Modbus

NOTE To be able to adjust parameter P-15, extended menu access must be set in P-14 (default value is 101)

4.10. Control Terminal Connections

Default Connections

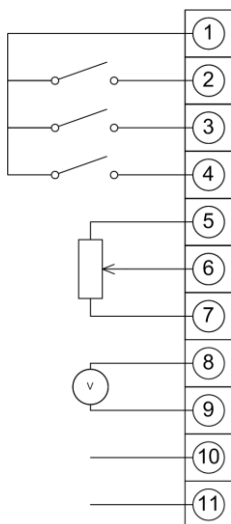





Control Terminal	Signal	Description
1	+24V User Output,	+24V, 100mA
2	Digital Input 1	Positive logic
3	Digital Input 2	"Logic 1" input voltage range: 8V ... 30V DC "Logic 0" input voltage range: 0V ... 4V DC
4	Digital Input 3 / Analog Input 2	Digital: 8 to 30V Analog: 0 to 10V, 0 to 20mA or 4 to 20mA
5	+10V User Output	+10V, 10mA, 1kΩ minimum
6	Analog Input 1 / Digital Input 4	Analog: 0 to 10V, 0 to 20mA or 4 to 20mA Digital: 8 to 30V
7	0V	User ground connected terminal 9
8	Analog Output / Digital Output	Analog: 0 to 10V, 20mA maximum Digital: 0 to 24V
9	0V	User ground connected terminal 7
10	Relay Common	
11	Relay NO Contact	Contact 250Vac, 6A / 30Vdc, 5A



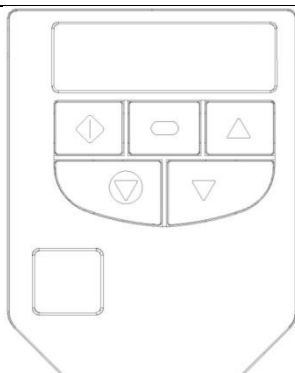



5. Operation

5.1. Managing the Keypad





The drive is configured and its operation monitored via the keypad and display.

	NAVIGATE	Used to display real-time information, to access and exit parameter edit mode and to store parameter changes	
	UP	Used to increase speed in real-time mode or to increase parameter values in parameter edit mode	
	DOWN	Used to decrease speed in real-time mode or to decrease parameter values in parameter edit mode	
	RESET / STOP	Used to reset a tripped drive. When in Keypad mode is used to Stop a running drive.	
	START	When in keypad mode, used to Start a stopped drive or to reverse the direction of rotation if bi-directional keypad mode is enabled	

Changing Parameters



To change a parameter value press and hold the  key for >1s whilst the drive displays $StOP$. The display changes to $P-01$, indicating parameter 01. Press and release the  key to display the value of this parameter. Change to the required value using the  and  keys. Press and release the  key once more to store the change. Press and hold the  key for >1s to return to real-time mode. The display shows $StOP$ if the drive is stopped or the real-time information (e.g. speed) if the drive is running.

Reset Factory Default Settings

To reset factory default parameters, press ,  and  for >2s. The display shows $P-dEF$. Press the  button to acknowledge and reset the drive.

5.2. Terminal Control











When delivered, the Optidrive is in the factory default state, meaning that it is set to operate in terminal control mode and all parameters (P-xx) have the default values as indicated in section 6 Parameters.

1. Connect the drive and motor according to the connection diagram shown at the beginning of this User Guide
2. Enter motor data from motor nameplate, P-07 = motor rated voltage, P-08 = motor rated current, P-09 = motor rated frequency.
3. With the potentiometer set to zero, switch on the supply to the drive. The display will show $StOP$.
4. Close the control switch, terminals 1-2. The drive is now 'enabled' and the output frequency/speed are controlled by the potentiometer. The display shows zero speed in Hz ($H 0.0$) with the potentiometer turned to minimum.
5. Turn the potentiometer to maximum. The motor will accelerate to 50Hz (the default value of P-01) under the control of the accelerating ramp time P-03. The display shows 50Hz ($H 50.0$) at max speed.
6. To display motor current (A), briefly press the  (Navigate) key.
7. Press  again to return to speed display.
8. To stop the motor, either turn the potentiometer back to zero or disable the drive by opening the control switch (terminals 1-2).





If the enable/disable switch is opened the drive will decelerate to stop at which time the display will show $StOP$. If the potentiometer is turned to zero with the enable/disable closed the display will show $H 0.0$ (0.0Hz), if left like this for 20 seconds the drive will go into standby mode, display shows $Stndby$, waiting for a speed reference signal.

5.3. Keypad Control

To allow the Optidrive to be controlled from the keypad in a forward direction only, set P-12 =1:

1. Connect the drive and motor according to the connection diagram shown at the beginning of this User Guide
2. Enable the drive by closing the switch between control terminals 1 & 2. The display will show $StOP$.
3. Press the  key. The display shows $H 0.0$.
4. Press  to increase speed.
5. The drive will run forward, increasing speed until  is released. The rate of acceleration is controlled by the setting of P-03, check this before starting.
6. Press  to decrease speed. The drive will decrease speed until  is released. The rate of deceleration is limited by the setting in P-04
7. Press the  key. The drive will decelerate to rest at the rate set in P-04.
8. The display will finally show $StOP$ at which point the drive is disabled
9. To preset a target speed prior to enable, press the  key whilst the drive is stopped. The display will show the target speed, use the  &  keys to adjust as required then press the  key to return the display to $StOP$.
10. Pressing the  key will start the drive accelerating to the target speed.

To allow the Optidrive to be controlled from the keypad in a forward and reverse direction, set P-12 =2:

11. Operation is the same as when P-12=1 for start, stop and changing speed.
12. Press the  key. The display changes to $H 0.0$.
13. Press  to increase speed
14. The drive will run forward, increasing speed until  is released. Acceleration is limited by the setting in P-03. The maximum speed is the speed set in P-01.
15. To reverse the direction of rotation of the motor, press the  key again.

6. Parameters

6.1. Standard Parameters

Par.	Description	Minimum	Maximum	Default	Units
P-01	Maximum Frequency / Speed Limit	P-02	500.0	50.0 (60.0)	Hz / Rpm
	Maximum output frequency or motor speed limit – Hz or rpm. If P-10 >0, the value entered / displayed is in Rpm				
P-02	Minimum Frequency / Speed Limit	0.0	P-01	0.0	Hz / Rpm
	Minimum speed limit – Hz or rpm. If P-10 >0, the value entered / displayed is in Rpm				
P-03	Acceleration Ramp Time	0.00	600.0	5.0	s
	Acceleration ramp time from 0.0 to base frequency (P-09) in seconds.				
P-04	Deceleration Ramp Time	0.00	600.0	5.0	s
	Deceleration ramp time from base frequency (P-09) to standstill in seconds. When set to 0.00, the value of P-24 is used.				
P-05	Stopping Mode	0	2	0	-
	0 : Ramp To Stop. When the enable signal is removed, the drive will ramp to stop, with the rate controlled by P-04. If the mains supply is lost, the drive will try to continue running by reducing the speed of the load, and using the load as a generator.				
	1 : Coast to Stop. When the enable signal is removed, or if the mains supply is lost, the motor will coast (freewheel) to stop				
	2 : Ramp To Stop. When the enable signal is removed, the drive will ramp to stop, with the rate controlled by P-04. If the mains supply is lost the drive will ramp to stop using the P-24 decel ramp with dynamic brake control.				
P-06	Energy Optimiser	0	1	0	-
	0 : Disabled 1 : Enabled. When enabled, the Energy Optimiser attempts to reduce the overall energy consumed by the drive and motor when operating at constant speeds and light loads. The output voltage applied to the motor is reduced. The Energy Optimiser is intended for applications where the drive may operate for some periods of time with constant speed and light motor load, whether constant or variable torque.				
P-07	Motor Rated Voltage	0	250 / 500	230 / 400	V
	This parameter should be set to the rated (nameplate) voltage of the motor (Volts)				
P-08	Motor Rated Current	Drive Rating Dependent			A
	This parameter should be set to the rated (nameplate) current of the motor				
P-09	Motor Rated Frequency	25	500	50 (60)	Hz
	This parameter should be set to the rated (nameplate) frequency of the motor				
P-10	Motor Rated Speed	0	30000	0	Rpm
	This parameter can optionally be set to the rated (nameplate) rpm of the motor. When set to the default value of zero, all speed related parameters are displayed in Hz, and the slip compensation for the motor is disabled. Entering the value from the motor nameplate enables the slip compensation function, and the Optidrive display will now show motor speed in estimated rpm. All speed related parameters, such as Minimum and Maximum Speed, Preset Speeds etc. will also be displayed in Rpm.				
P-11	Voltage Boost	0.0	20.0	3.0	%
	Voltage boost is used to increase the applied motor voltage at low output frequencies, in order to improve low speed and starting torque. Excessive voltage boost levels may result in increased motor current and temperature, and force ventilation of the motor may be required. A suitable setting can usually be found by operating the motor under low load or no load conditions at approximately 5Hz, and adjusting P-11 until the motor current is no more than 80% of the rated full load current.				
P-12	Primary Command Source	0	6	0	-
	0: Terminal Control. The drive responds directly to signals applied to the control terminals.				
	1: Uni-directional Keypad Control. The drive can be controlled in the forward direction only using an external or remote Keypad				
	2: Bi-directional Keypad Control. The drive can be controlled in the forward and reverse directions using an external or remote Keypad. Pressing the keypad START button toggles between forward and reverse.				
	3: Modbus Network Control. Control via Modbus RTU (RS485) using the internal Accel / Decel ramps				
	4 : Modbus Network Control. Control via Modbus RTU (RS485) interface with Accel / Decel ramps updated via Modbus				
P-13	Trip Log History	N/A	N/A	N/A	N/A
	Previous 4 trips stored in order of occurrence, with the most recent first. Press UP or DOWN to step through all four. The most recent trip is always displayed first. UV trip is only stored once. Further fault event logging functions are available through parameter group zero.				
P-14	Extended Menu Access code	0	9999	0	-
	Set to "101" (default) for extended menu access. Change code in P-37 to prevent unauthorised access to the Extended Parameter Set				

6.2. Extended Parameters

Par.	Description	Minimum	Maximum	Default	Units
P-15	Digital Input Function Select	0	12	0	-
	Defines the function of the digital inputs depending on the control mode setting in P-12. See section 8, Analog and Digital Input Configurations for more information.				
P-16	Analog Input 1 Signal Format	See Below		U0-10	-
	U 0- 10 = 0 to 10 Volt Signal (Uni-polar). The drive will remain at 0.0Hz if the analog reference after scaling and offset are applied is <0.0%				
	b- 10- 10 = 0 to 10 Volt Signal (Bi-polar). The drive will operate the motor in the reverse direction of rotation if the analog reference after scaling and offset are applied is <0.0%				
	A 0-20 = 0 to 20mA Signal				
	t 4-20 = 4 to 20mA Signal, the Optidrive will trip and show the fault code 4-20F if the signal level falls below 3mA				
	r 4-20 = 4 to 20mA Signal, the Optidrive will run at Preset Speed 1 (P-20) if the signal level falls below 3mA				
P-17	Maximum Effective Switching Frequency	4	32	8 / 16	kHz
	Sets maximum effective switching frequency of the drive. If "rEd" is displayed, the switching frequency has been reduced to the level in P00-14 due to excessive drive heatsink temperature.				
P-18	Output Relay Function Select	0	7	1	-
	Selects the function assigned to the relay output. The relay has two output terminals, Logic 1 indicates the relay is active, and therefore terminals 10 and 11 will be linked together.				
	0 : Drive Enabled (Running). Logic 1 when the motor is enabled				
	1 : Drive Healthy. Logic 1 when power is applied to the drive and no fault exists				
	2 : At Target Frequency (Speed). Logic 1 when the output frequency matches the setpoint frequency				
	3: Drive Tripped. Logic 1 when the drive is in a fault condition				
	4 : Output Frequency >= Limit. Logic 1 when the output frequency exceeds the adjustable limit set in P-19				
	5 : Output Current >= Limit. Logic 1 when the motor current exceeds the adjustable limit set in P-19				
P-19	Relay Threshold Level	0.0	200.0	100.0	%
	Adjustable threshold level used in conjunction with settings 4 to 7 of P-18				
P-20	Preset Frequency / Speed 1	P-02	P-01	0.0	Hz / Rpm
P-21	Preset Frequency / Speed 2	P-02	P-01	0.0	Hz / Rpm
P-22	Preset Frequency / Speed 3	P-02	P-01	0.0	Hz / Rpm
P-23	Preset Frequency / Speed 4	P-02	P-01	0.0	Hz / Rpm
	Preset Speeds / Frequencies selected by digital inputs depending on the setting of P-15 If P-10 = 0, the values are entered as Hz. If P-10 > 0, the values are entered as Rpm.				
P-24	2nd Decel Ramp Time (Fast Stop)	0.00	25.0	0.00	s
	This parameter allows an alternative deceleration ramp down time to be programmed into the Optidrive, which can be selected by digital inputs (dependent on the setting of P-15) or selected Automatically in the case of a mains power loss if P-05 = 2. When set to 0.00, the drive will coast to stop.				
P-25	Analog Output Function Select	0	9	8	-
	Digital Output Mode. Logic 1 = +24V DC				
	0 : Drive Enabled (Running). Logic 1 when the Optidrive is enabled (Running)				
	1 : Drive Healthy. Logic 1 When no Fault condition exists on the drive				
	2 : At Target Frequency (Speed). Logic 1 when the output frequency matches the setpoint frequency				
	3: Drive Tripped. Logic 1 when the drive is in a fault condition				
	4 : Output Frequency >= Limit. Logic 1 when the output frequency exceeds the adjustable limit set in P-19				
	5 : Output Current >= Limit. Logic 1 when the motor current exceeds the adjustable limit set in P-19				
	6 : Output Frequency < Limit. Logic 1 when the output frequency is below the adjustable limit set in P-19				
	7 : Output Current < Limit. Logic 1 when the motor current is below the adjustable limit set in P-19				
Analog Output Mode					
8 : Output Frequency (Motor Speed). 0 to P-01, resolution 0.1Hz					
9 : Output (Motor) Current. 0 to 200% of P-08, resolution 0.1A					
P-26	Skip frequency hysteresis band	0.0	P-01	0.0	Hz / Rpm
P-27	Skip Frequency	0.0	P-01	0.0	Hz / Rpm
	The Skip Frequency function is used to avoid the Optidrive operating at a certain output frequency, for example at a frequency which causes mechanical resonance in a particular machine. Parameter P-27 defines the centre point of the skip frequency band, and is used in conjunction with P-26. The Optidrive output frequency will ramp through the defined band at the rates set in P-03 and P-04 respectively, and will not hold any output frequency within the defined band. If the frequency reference applied to the drive is within the band, the Optidrive output frequency will remain at the upper or lower limit of the band.				
P-28	V/F Characteristic Adjustment Voltage	0	250 / 500	0	V
P-29	V/F Characteristic Adjustment Frequency	0.0	P-09	0.0	Hz
	This parameter in conjunction with P-28 sets a frequency point at which the voltage set in P-29 is applied to the motor. Care must be taken to avoid overheating and damaging the motor when using this feature. See section 6.3 for further information.				

Par.	Description	Minimum	Maximum	Default	Units
P-30	Terminal Mode Restart function Defines the behaviour of the drive relating to the enable digital input and also configures the Automatic Restart function. EdSE-r : Following Power on or reset, the drive will not start if Digital Input 1 remains closed. The Input must be closed after a power on or reset to start the drive. Auto-0 : Following a Power On or Reset, the drive will automatically start if Digital Input 1 is closed. Auto-1 to Auto-5 : Following a trip, the drive will make up to 5 attempts to restart at 20 second intervals. The drive must be powered down to reset the counter. The numbers of restart attempts are counted, and if the drive fails to start on the final attempt, the drive will fault with, and will require the user to manually reset the fault.	N/A	N/A	Auto-0	-
P-31	Keypad / Modbus Mode Restart Function This parameter is active only when operating in Keypad Control Mode (P-12 = 1 or 2) or Modbus Mode (P-12 = 3 or 4). When settings 0 or 1 are used, the Keypad Start and Stop keys are active, and control terminals 1 and 2 must be linked together. Settings 2 and 3 allow the drive to be started from the control terminals directly, and the keypad Start and Stop keys are ignored. Settings 0 and 2 : The drive will always start at the Minimum Frequency / Speed (P-02) Settings 1 and 3 : The drive will always start at the last operating Frequency / Speed 0 : Minimum Speed, Keypad Start 1 : Previous Speed, Keypad Start 2 : Minimum Speed, Terminal Enable 3 : Previous Speed, Terminal Enable	0	3	1	-
P-32	DC Injection Time On Stop Defines the time for which a DC current is injected into the motor once the output frequency reaches 0.0Hz. The voltage level is the same as the boost level set in P-11.	0.0	25.0	0.0	s
P-33	Spin Start (S2 & S3 Only) / DC Injection Time On Start (S1 Only) Frame Size 2 and 3 Drives only – Spin Start 0 : Disabled 1 : Enabled. When enabled, on start up the drive will attempt to determine if the motor is already rotating, and will begin to control the motor from its current speed. A short delay may be observed when starting motors which are not turning. Frame Size 1 Drives Only – DC Injection Time On Starting Sets a time for which DC current is injected into the motor to ensure it is stopped when the drive is enabled.	0	1	0	-
P-34	Brake Chopper Enable 0 : Disabled 1 : Enabled With Software Protection. Enables the internal brake chopper with software protection for a 200W continuous rated resistor 2 : Enabled Without Software Protection. Enables the internal brake chopper without software protection. An external thermal protection device should be fitted.	0	2	0	-
P-35	Analog Input 1 Scaling Scales the analog input by this factor, e.g. if P-16 is set for a 0 – 10V signal, and the scaling factor is set to 200.0%, a 5 volt input will result in the drive running at maximum frequency / speed (P-01)	0.0	500.0	100.0	%
P-36	Serial Communications Configuration This parameter has three sub settings used to configure the Modbus RTU Serial Communications. The Sub Parameters are 1st Index : Drive Address : Range Adr- 0 - 63 2nd Index : Protocol & Baud Rate : Setting DP-bUS (factory default setting) disables Modbus communications, and allows the Optistick to be used with the drive. Selecting a baud rate between 9.6kbps to 115.2kbps allows Modbus communication, but disables the operation of the Optistick. 3rd Index : Watchdog Timeout : Defines the time for which the drive will operate without receiving a valid command telegram to Register 1 (Drive Control Word) after the drive has been enabled. Setting 0 disables the Watchdog timer. Setting a value of 30, 100, 1000, or 3000 defines the time limit in milliseconds for operation. A 'L' suffix selects trip on loss of communication. An 'R' suffix means that the drive will coast stop (output immediately disabled) but will not trip.	See Below			
P-37	Access Code Definition Defines the access code which must be entered in P-14 to access parameters above P-14	0	9999	101	-
P-38	Parameter Access Lock 0 : Unlocked. All parameters can be accessed and changed 1 : Locked. Parameter values can be displayed, but cannot be changed	0	1	0	-
P-39	Analog Input 1 Offset Sets an offset, as a percentage of the full scale range of the input, which is applied to the analog input signal	-500.0	500.0	0.0	%
P-40	Display Speed Scaling Factor Allows the user to program the Optidrive to display an alternative output unit scaled from the output frequency or speed, e.g. to display conveyer speed in metres per second. This function is disabled if P-40 = 0.00	0.000	6.000	0.000	-
P-41	PI Controller Proportional Gain PI Controller Proportional Gain. Higher values provide a greater change in the drive output frequency in response to small changes in the feedback signal. Too high a value can cause instability	0.0	30.0	1.0	-
P-42	PI Controller Integral Time PI Controller Integral Time. Larger values provide a more damped response for systems where the overall process responds slowly	0.0	30.0	1.0	s
P-43	PI Controller Operating Mode 0 : Direct Operation. Use this mode if an increase in the motor speed should result in an increase in the feedback signal 1 : Inverse Operation. Use this mode if an increase in the motor speed should result in a decrease in the feedback signal	0	1	0	-

Par.	Description	Minimum	Maximum	Default	Units
P-44	PI Reference (Setpoint) Source Select Selects the source for the PID Reference / Setpoint 0 : Digital Preset Setpoint. P-45 is used 1 : Analog Input 1 Setpoint	0	1	0	-
P-45	PI Digital Setpoint When P-44 = 0, this parameter sets the preset digital reference (setpoint) used for the PI Controller	0.0	100.0	0.0	%
P-46	PI Feedback Source Select 0 : Analog Input 2 (Terminal 4) 1 : Analog Input 1 (Terminal 6) 2 : Motor Current 3 : DC Bus Voltage Scaled 0 – 1000 Volts = 0 – 100% 4 : Analog 1 – Analog 2. The value of Analog Input 2 is subtracted from Analog 1 to give a differential signal. The value is limited to 0. 5 : Largest (Analog 1, Analog 2). The largest of the two analog input values is always used for PI feedback	0	2	0	-
P-47	Analog Input 2 Signal Format U 0-10 = 0 to 10 Volt Signal R 0-20 = 0 to 20mA Signal t 4-20 = 4 to 20mA Signal, the Optidrive will trip and show the fault code 4-20F if the signal level falls below 3mA r 4-20 = 4 to 20mA Signal, the Optidrive will ramp to stop if the signal level falls below 3mA t 20-4 = 20 to 4mA Signal, the Optidrive will trip and show the fault code 4-20F if the signal level falls below 3mA r 20-4 = 20 to 4mA Signal, the Optidrive will ramp to stop if the signal level falls below 3mA	N/A	N/A	N/A	U0-10
P-48	Standby Mode Timer When standby mode is enabled, the drive will enter standby mode following a period of operating at minimum speed (P-02) for the time set in P-48. When in Standby Mode, the drive display shows Stndby , and the output to the motor is disabled. Standby mode can be disabled by setting P-48 = 0.0	0.0	250.0	20.0	s
P-49	PI Control Wake Up Error Level When the drive is operating in PI Control Mode (P-12 = 5 or 6), and Standby Mode is enabled (P-48 > 0.0), P-49 can be used to define the PI Error Level (E.g. difference between the setpoint and feedback) for which the drive will remain in Standby Mode. This allows the drive to ignore small feedback errors and remain in Standby mode until the feedback drops sufficiently.	0.0	100.0	0.0	%
P-50	Thermal Overload Value Retention 0 : Disabled. 1 : Enabled. All Optidrives feature electronic thermal overload protection for the connected motor, designed to protect the motor against damage. An internal overload accumulator monitors the motor output current over time, and will trip the drive if the usage exceeds the thermal limit. When P-50 is disabled, removing the power supply from the drive and re-applying will reset the value of the accumulator. When P-50 is enabled, the value is retained during power off.	0	1	0	-

6.3. Adjusting the Voltage / Frequency (V/f) characteristics

The V/f characteristic is defined by several parameters as follows :-

- P-07 : Motor Rated Voltage
- P-09 : Motor Rated Frequency

The voltage set in parameter P-07 is applied to the motor at the frequency set Under normal operating conditions, the voltage is linearly reduced at any point below the motor rated frequency to maintain a constant motor torque output as shown by the line 'A' on the graph.

By using parameters P-28 and P-29, the voltage to be applied at a particular frequency can be directly set by the user, thereby altering the V/F characteristic.

Reducing the voltage at a particular frequency reduces the current in the motor and hence the torque and power, hence this function can be used in fan and pump applications where a variable torque output is desired by setting the parameters as follows :-

- P-28 = P-07 / 4
- P-29 = P-09 / 2

This function can also be useful if motor instability is experienced at certain frequencies, if this is the case increase or decrease the voltage (P-28) at the speed of instability (P-29).

For applications requiring energy saving, typically HVAC and pumping, the energy optimiser (P-06) parameter can be enabled. This automatically reduces the applied motor voltage on light load.

6.4. P-00 Read Only Status Parameters



	Description	Display range	Explanation
P00-01	1st Analog input value	0 ... 100%	100% = max input voltage
P00-02	2nd Analog input value	0 ... 100%	100% = max input voltage
P00-03	Speed reference input	-P-01 ... P-01	Displayed in Hz if P-10 = 0, otherwise displayed in RPM
P00-04	Digital input status	Binary value	Drive digital input status
P00-05	Reserved	0	Reserved
P00-06	Reserved	0	Reserved
P00-07	Applied motor voltage	0 ... 600V AC	Value of RMS voltage applied to motor
P00-08	DC bus voltage	0 ... 1000V dc	Internal DC bus voltage
P00-09	Internal Heatsink temperature	-20 ... 100 °C	Temperature of heatsink in °C
P00-10	Hours run meter	0 to 99 999 hours	Not affected by resetting factory default parameters
P00-11	Run time since last trip (1)	0 to 99 999 hours	Run-time clock stopped by drive disable (or trip), reset on next enable only if a trip occurred. Reset also on next enable after a drive power down.
P00-12	Run time since last trip (2)	0 to 99 999 hours	Run-time clock stopped by drive disable (or trip), reset on next enable only if a trip occurred (under-volts not considered a trip) – not reset by power down / power up cycling unless a trip occurred prior to power down
P00-13	Run time since last disable	0 to 99 999 hours	Run-time clock stopped on drive disable, value reset on next enable
P00-14	Drive Effective Switching Frequency	4 to 32 kHz	Actual drive effective output switching frequency. This value maybe lower than the selected frequency in P-17 if the drive is too hot. The drive will automatically reduce the switching frequency to prevent an over temperature trip and maintain operation.
P00-15	DC bus voltage log	0 ... 1000V	8 most recent values prior to trip, updated every 250ms
P00-16	Thermistor temperature log	-20 ... 120 °C	8 most recent values prior to trip, updated every 500ms
P00-17	Motor current	0 to 2x rated current	8 most recent values prior to trip, updated every 250ms
P00-18	Software ID, IO & motor ctrl	e.g. "1.00", "47AE"	Version number and checksum. "1" on LH side indicates I/O processor, "2" indicates motor control
P00-19	Drive serial number	000000 ... 999999 00-000 ... 99-999	Unique drive serial number e.g. 540102 / 32 / 005
P00-20	Drive identifier	Drive rating	Drive rating, drive type e.g. 0.37, 1 230,3P-out





Parameter group zero access and navigation



When P-14 = P-37, all P-00 parameters are visible. Default value is 101.

When the user scrolls to P-00, pressing  will display "P00-XX", where XX represents the secondary number within P-00. (i.e. 1 to 20). The User can then scroll to the required P-00 parameter.

Pressing  once more will then display the value of that particular group zero parameter.

For those parameters which have multiple values (e.g. software ID), pressing the  and  keys will display the different values within that parameter.

Pressing  returns to the next level up. If  is then pressed again (without pressing  or ) , the display changes to the next level up (main parameter level, i.e. P-00).

If  or  is pressed whilst on the lower level (e.g. P00-05) to change the P-00 index, pressing <NAVIGATE> quickly displays that parameter value.

7. Analog and Digital Input Configurations

7.1. Terminal Mode (P-12 = 0)

P-15	Digital input 1 (T2)	Digital input 2 (T3)	Digital input 3 (T4)	Analog input (T6)	Comments
0	Open: Stop (disable) Closed: Run (enable)	Open : Forward run Closed : Reverse run	Open : Analog speed ref Closed : Preset speed 1	Analog input 1 reference	
1	Open: Stop (disable) Closed: Run (enable)	Open: Analog speed ref Closed : Preset speed 1/2	Open: Preset speed 1 Closed : Preset speed 2	Analog input 1 reference	
2	Open: Stop (disable) Closed: Run (enable)	Digital Input 2	Digital Input 3	Preset Speed	Open: Preset speeds 1-4 Closed : Max Speed(P-01)
		Open	Open	Preset Speed 1	
		Closed	Open	Preset Speed 2	
		Open	Closed	Preset Speed 3	
		Closed	Closed	Preset Speed 4	
3	Open: Stop (disable) Closed: Run (enable)	Open : Analog speed ref Closed : Preset speed 1	External trip input : Open: Trip, Closed: Run	Analog input 1 reference	Connect external motor thermistor PTC type or similar to digital input 3
4	Open: Stop (disable) Closed: Run (enable)	Open : Analog input 1 Closed : Analog input 2	Analog input 2 reference	Analog input 1 reference	Switches between analog inputs 1 and 2
5	Open: Fwd Stop Closed: Fwd Run	Open: Reverse Stop Closed: Reverse Run	Open : Analog speed ref Closed : Preset speed 1	Analog input 1 reference	Closing digital inputs 1 and 2 together carries out a fast stop (P-24)
6	Open: Stop (disable) Closed: Run (enable)	Open : Forward Closed : Reverse	External trip input : Open: Trip, Closed: Run	Analog input 1 reference	Connect external motor thermistor PTC type or similar to digital input 3
7	Open: Stop (disable) Closed: Fwd Run (enable)	Open: Stop (disable) Closed: Rev Run (enable)	External trip input : Open: Trip, Closed: Run	Analog input 1 reference	Closing digital inputs 1 and 2 together carries out a fast stop (P-24)
8	Open: Stop (disable) Closed: Run (enable)	Open : Forward Closed : Reverse	Digital Input 3	Analog Input 1	Preset Speed
			Open	Open	Preset Speed 1
			Closed	Open	Preset Speed 2
			Open	Closed	Preset Speed 3
			Closed	Closed	Preset Speed 4
9	Open: Stop (disable) Closed: Forward Run (enable)	Open: Stop (disable) Closed: Reverse Run (enable)	Digital Input 3	Analog Input 1	Preset Speed
			Open	Open	Preset Speed 1
			Closed	Open	Preset Speed 2
			Open	Closed	Preset Speed 3
			Closed	Closed	Preset Speed 4
10	Normally Open (NO) Momentary close to run	Normally Closed (NC) Momentary open to stop	Open : Analog speed ref Closed:Preset speed 1	Analog input 1 reference	
11	Normally Open (NO) Momentary close to run	Normally Closed (NC) Momentary open to stop	Normally Open (NO) Momentary close to rev	Analog input 1 reference	Closing digital inputs 1 and 3 together carries out a fast stop (P-24)
12	Open: Stop (disable) Closed: Run (enable)	Open: Fast Stop (disable) Closed: Run (enable)	Open : Analog speed ref Closed : Preset speed 1	Analog input 1 reference	
NOTE	Negative Preset Speeds will be inverted if Run Reverse selected				

Typical Applications

Terminal Mode P-12=0, P-15=0	Terminal Mode P-12=0, P-15 = 1	Terminal Mode P-12=0, P-15=2
Analog speed input with 1 preset speed and fwd/rev switch	Analog speed input with 2 preset speeds	4 preset speeds and max speed select switch. Effectively giving 5 preset speeds

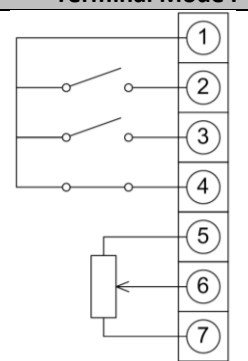
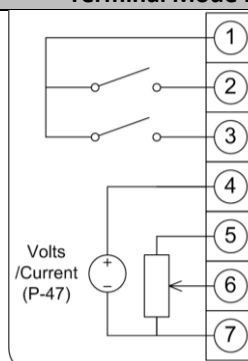
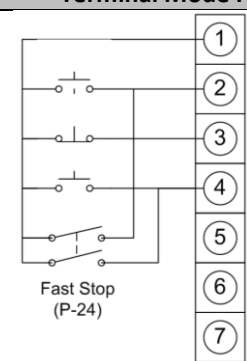
Terminal Mode P-12=0, P-15=3	Terminal Mode P-12=0, P-15=4	Terminal Mode P-12=0, P-15=11																																										
																																												
<table border="1"> <tr><td>1</td><td>+24 Volt</td></tr> <tr><td>2</td><td>Run (Enable)</td></tr> <tr><td>3</td><td>Analog / Preset 1</td></tr> <tr><td>4</td><td>External Trip</td></tr> <tr><td>5</td><td>+ 10 Volts</td></tr> <tr><td>6</td><td>Reference</td></tr> <tr><td>7</td><td>0 Volts</td></tr> </table>	1	+24 Volt	2	Run (Enable)	3	Analog / Preset 1	4	External Trip	5	+ 10 Volts	6	Reference	7	0 Volts	<table border="1"> <tr><td>1</td><td>+24 Volt</td></tr> <tr><td>2</td><td>Run (Enable)</td></tr> <tr><td>3</td><td>Local / Remote (Hand / Auto)</td></tr> <tr><td>4</td><td>Remote (Auto) Reference</td></tr> <tr><td>5</td><td>+ 10 Volts</td></tr> <tr><td>6</td><td>Local (Hand) Reference</td></tr> <tr><td>7</td><td>0 Volts</td></tr> </table>	1	+24 Volt	2	Run (Enable)	3	Local / Remote (Hand / Auto)	4	Remote (Auto) Reference	5	+ 10 Volts	6	Local (Hand) Reference	7	0 Volts	<table border="1"> <tr><td>1</td><td>+24 Volt</td></tr> <tr><td>2</td><td>Run Forward</td></tr> <tr><td>3</td><td>Stop</td></tr> <tr><td>4</td><td>Run Reverse</td></tr> <tr><td>5</td><td>+ 10 Volts</td></tr> <tr><td>6</td><td>Reference</td></tr> <tr><td>7</td><td>0 Volts</td></tr> </table>	1	+24 Volt	2	Run Forward	3	Stop	4	Run Reverse	5	+ 10 Volts	6	Reference	7	0 Volts
1	+24 Volt																																											
2	Run (Enable)																																											
3	Analog / Preset 1																																											
4	External Trip																																											
5	+ 10 Volts																																											
6	Reference																																											
7	0 Volts																																											
1	+24 Volt																																											
2	Run (Enable)																																											
3	Local / Remote (Hand / Auto)																																											
4	Remote (Auto) Reference																																											
5	+ 10 Volts																																											
6	Local (Hand) Reference																																											
7	0 Volts																																											
1	+24 Volt																																											
2	Run Forward																																											
3	Stop																																											
4	Run Reverse																																											
5	+ 10 Volts																																											
6	Reference																																											
7	0 Volts																																											
Analog speed input with 1 preset speed and motor thermistor trip	Local or remote analog speeds (2 analog inputs)	Push button fwd/rev/stop with fast stop using 2 nd deceleration ramp																																										

7.2. Keypad Mode (P-12 = 1 or 2)

P-15	Digital input 1 (T2)	Digital input 2 (T3)	Digital input 3 (T4)	Analog input (T6)	Comments
0, 5, 8..12	Open: Stop (disable) Closed: Run (enable)	Closed : remote UP push-button	Closed : remote DOWN push-button	Open : Forward +24V : Reverse	
1	Open: Stop (disable) Closed: Run (enable)	No effect	No effect	No effect	Speed reference = PI Controller Output
2	Open: Stop (disable) Closed: Run (enable)	Closed : remote UP push-button	Closed : remote DOWN push-button	Open : Keypad speed ref +24V : Preset speed 1	
3 ¹⁾	Open: Stop (disable) Closed: Run (enable)	Closed : remote UP push-button	External trip input : Open: Trip, Closed: Run	Closed : remote DOWN push-button	Connect external motor thermistor PTC type or similar to digital input 3
4	Open: Stop (disable) Closed: Run (enable)	Closed : remote UP push-button	Open : Keypad speed ref Closed : Analog input 1	Analog input 1	
6 ¹⁾	Open: Stop (disable) Closed: Run (enable)	Open : Forward run Closed : Reverse run	External trip input : Open: Trip, Closed: Run	Open : Keypad speed ref +24V : Preset speed 1	Connect external motor thermistor PTC type or similar to digital input 3
7	Open: Forward Stop Closed: Forward Run	Open: Reverse Stop Closed: Reverse Run	External trip input : Open: Trip, Closed: Run	Open : Keypad speed ref +24V : Preset speed 1	Closing digital inputs 1 and 2 together carries out a fast stop (P-24)

Example Wiring

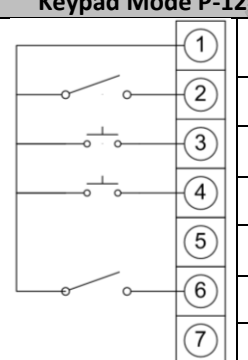
Keypad Mode P-12=1 or 2, P-15=0															
	<table border="1"> <tr><td>1</td><td>+24 Volt</td></tr> <tr><td>2</td><td>Run (Enable)</td></tr> <tr><td>3</td><td>Increase Speed</td></tr> <tr><td>4</td><td>Reduce Speed</td></tr> <tr><td>5</td><td>+ 10 Volts</td></tr> <tr><td>6</td><td>Forward / Reverse</td></tr> <tr><td>7</td><td>0 Volts</td></tr> </table>	1	+24 Volt	2	Run (Enable)	3	Increase Speed	4	Reduce Speed	5	+ 10 Volts	6	Forward / Reverse	7	0 Volts
1	+24 Volt														
2	Run (Enable)														
3	Increase Speed														
4	Reduce Speed														
5	+ 10 Volts														
6	Forward / Reverse														
7	0 Volts														
Remote push button speed control with fwd/rev															

NOTE

By default if the enable signal is present the drive will not Enable until the START button is pressed. To automatically enable the drive when the enable signal is present set P-31 = 2 or 3. This then disables the use of the START & STOP buttons

7.3. Modbus Control Mode (P-12 = 4)

P-15	Digital input 1 (T2)	Digital input 2 (T3)	Digital input 3 (T4)	Analog input (T6)	Comments
0, 2, 4..5, 8..12	Open: Stop (disable) Closed: Run (enable)	No effect	No effect	No effect	Run and stop commands given via the RS485 link and Digital input 1 must be closed for the drive to run.
1	Open: Stop (disable) Closed: Run (enable)	No effect	No effect	No effect	Speed reference = PI Controller Output
3 ¹⁾	Open: Stop (disable) Closed: Run (enable)	Open : Master speed ref Closed : Preset speed 1	External trip input : Open: Trip, Closed: Run	No effect	Connect external motor thermistor PTC type or similar to digital input 3
6 ¹⁾	Open: Stop (disable) Closed: Run (enable)	Open : Master speed ref Closed : Analog input	External trip input : Open: Trip, Closed: Run	Analog input reference	Master Speed Ref - start and stop controlled via RS485.
7 ¹⁾	Open: Stop (disable) Closed: Run (enable)	Open : Master speed ref Closed : keypad speed ref	External trip input : Open: Trip, Closed: Run	No effect	Keypad Speed Ref - drive auto runs if digital input 1 closed, depending on P-31 setting

For further information on the MODBUS RTU Register Map information and communication setup; please contact your Invertek Drives Sales Partner.

7.4. User PI Control Mode

P-15	Digital input 1 (T2)	Digital input 2 (T3)	Digital input 3 (T4)	Analog input (T6)	Comments
0, 2, 9..12	Open: Stop (disable) Closed: Run (enable)	Open : PI control Closed : Preset speed 1	PI feedback analog input	Analog input 1	Analog Input 1 can provide an adjustable PI setpoint, by setting P-44 = 1
1	Open: Stop (disable) Closed: Run (enable)	Open : PI control Closed : Analog input 1	PI feedback analog input	Analog input 1	Analog Input 1 can provide an adjustable PI setpoint, by setting P-44 = 1
3, 7 ¹⁾	Open: Stop (disable) Closed: Run (enable)	Open : PI control Closed : Preset speed 1	External trip input : Open: Trip, Closed: Run	PI feedback analog input	Connect external motor thermistor PTC type or similar to digital input 3
4	Normally Open (NO) Momentary close to run	Normally Closed (NC) Momentary open to stop	PI Feedback Analog Input	Analog Input 1	Normally Open (NO) Momentary close to run
5	Normally Open (NO) Momentary close to run	Normally Closed (NC) Momentary open to stop	Open: PI Control Closed: Preset Speed 1	PI Feedback Analog Input	Normally Open (NO) Momentary close to run
6	Normally Open (NO) Momentary close to run	Normally Closed (NC) Momentary open to stop	Open: External Trip Closed: Run	PI Feedback Analog Input	Normally Open (NO) Momentary close to run
8	Open: Stop (disable) Closed: Run (enable)	Open : Forward run Closed : Reverse run	PI feedback analog input	Analog input 1	Analog Input 1 can provide an adjustable PI setpoint, by setting P-44 = 1

Example Wiring

PI Mode P-12=5, P-15=0	PI Mode P-12=5, P-15=1	PI Mode P-12=5, P-15=3
Remote closed loop PI feedback control with Local Preset speed 1	Remote closed loop PI feedback control with Local Analog speed input	Remote closed loop PI feedback control with Local Preset speed 1 and motor thermistor trip

NOTE By default the PI reference is set for a digital reference level set in P-45. When using an Analog reference set P-44 = 1 (analog) and connect reference signal to analog input 1 (T6). The default settings for proportional gain (P-41), integral gain (P-42) and feedback mode (P-43) are suitable for most HVAC and pumping applications. The analog reference used for PI controller can also be used as the local speed reference when P15=1.

7.5. Motor Thermistor Connection

	<p>1 : + 24 Volt</p> <p>4 : External Trip</p>	<p>The motor thermistor should be connected between terminals 1 and 4 as shown. A setting of P-15 where Digital Input 3 is programmed for 'External Trip' must be used. The current flow through the thermistor is automatically controlled to prevent a failure.</p>
--	-----------------------------------------------	-----------------------------------------------------------------------------------------------------------------------------------------------------------------------------------------------------------------------------------------------------------------------

8. Modbus RTU Communications

8.1. Introduction

The Optidrive E2 can be connected to a Modbus RTU network via the RJ45 connector on the front of the drive.

8.2. Modbus RTU Specification

Protocol	Modbus RTU
Error check	CRC
Baud rate	9600bps, 19200bps, 38400bps, 57600bps, 115200bps (default)
Data format	1 start bit, 8 data bits, 1 stop bits, no parity.
Physical signal	RS 485 (2-wire)
User interface	RJ45

8.3. RJ45 Connector Configuration

For full MODBUS RTU register map information please refer to your Invertek Drives Sales Partner.

When using MODBUS control the Analog and Digital Inputs can be configured as shown in section 7.3

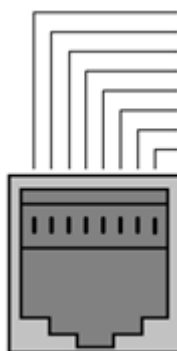

- 1 No Connection
- 2 No Connection
- 3 0 Volts
- 4 -RS485 (PC)
- 5 +RS485 (PC)
- 6 +24 Volt
- 7 -RS485 (Modbus RTU)
- 8 +RS485 (Modbus RTU)

Warning:

This is not an Ethernet connection. Do not connect directly to an Ethernet port.

8.4. Modbus Telegram Structure

The Optidrive ODE-2 supports Master / Slave Modbus RTU communications, using the 03 Read Holding Registers and 06 Write Single Holding Register commands. Many Master devices treat the first Register address as Register 0, therefore it may be necessary to convert the Register Numbers detail in section 8.5 by subtracting 1 to obtain the correct Register address. The telegram structure is as follows:-

Master Telegram	Length	Slave Response	Length
Slave Address	1 Byte	Slave Address	1 Byte
Function Code (03)	1 Byte	Starting Address	1 Byte
1 st Register Address	2 Bytes	1 st Register Value	2 Bytes
No. Of Registers	2 Bytes	2 nd Register Value	2 Bytes
CRC Checksum	2 Bytes	Etc...	
		CRC Checksum	2 Bytes

Master Telegram	Length	Slave Response	Length
Slave Address	1 Byte	Slave Address	1 Byte
Function Code (06)	1 Byte	Function Code (06)	1 Byte
Register Address	2 Bytes	Register Address	2 Bytes
Value	2 Bytes	Register Value	2 Bytes
CRC Checksum	2 Bytes	CRC Checksum	2 Bytes

8.5. Modbus Register Map

Register Number	Par.	Type	Supported Commands	Function		Range	Explanation
				Low Byte	High Byte		
1	-	R/W	03,06	Drive Control Command		0..3	16 Bit Word. Bit 0 : Low = Stop, High = Run Enable Bit 1 : Low = Decel Ramp 1 (P-04), High = Decel Ramp 2 (P-24) Bit 2 : Low = No Function, High = Fault Reset Bit 3 : Low – No Function, High = Coast Stop Request
2	-	R/W	03,06	Modbus Speed reference setpoint		0..5000	Setpoint frequency x10, e.g. 100 = 10.0Hz
4	-	R/W	03,06	Acceleration and Deceleration Time		0..60000	Ramp time in seconds x 100, e.g. 250 = 2.5 seconds
6	-	R	03	Error code	Drive status		Low Byte = Drive Error Code, see section 10.1 High Byte = Drive Status as follows :- 0 : Drive Stopped 1: Drive Running 2: Drive Tripped
7		R	03	Output Motor Frequency		0..20000	Output frequency in Hz x10, e.g. 100 = 10.0Hz
8		R	03	Output Motor Current		0..480	Output Motor Current in Amps x10, e.g. 10 = 1.0 Amps
11	-	R	03	Digital input status		0..15	Indicates the status of the 4 digital inputs Lowest Bit = 1 Input 1
20	P00-01	R	03	Analog Input 1 value		0..1000	Analog input % of full scale x10, e.g. 1000 = 100%
21	P00-02	R	03	Analog Input 2 value		0..1000	Analog input % of full scale x10, e.g. 1000 = 100%
22	P00-03	R	03	Speed Reference Value		0..1000	Displays the setpoint frequency x10, e.g. 100 = 10.0Hz
23	P00-08	R	03	DC bus voltage		0..1000	DC Bus Voltage in Volts
24	P00-09	R	03	Drive temperature		0..100	Drive heatsink temperature in °C

All user configurable parameters are accessible as Holding Registers, and can be Read from or Written to using the appropriate Modbus command. The Register number for each parameter P-04 to P-047 is defined as 128 + Parameter number, e.g. for parameter P-15, the register number is 128 + 15 = 143. Internal scaling is used on some parameters, for further details, please contact your Invertek Drives Sales Partner.

9. Technical Data

9.1. Environmental

Operational ambient temperature range	Open Drives	:	-10 ... 50°C (frost and condensation free)
	Enclosed Drives	:	-10 ... 40°C (frost and condensation free)
Storage ambient temperature range		:	-40 ... 60°C
Maximum altitude		:	2000m. Derate above 1000m : 1% / 100m
Maximum humidity		:	95%, non-condensing

NOTE For UL compliance: the average ambient temperature over a 24 hour period for 200-240V, 2.2kW and 3HP, IP20 drives is 45°C.

9.2. Rating Tables

110 - 115 Volt (+ / - 10%) 1 Phase Input, 3 Phase 230V Output

kW	HP	Nominal Input Current	Fuse Or MCB (Type B)		Supply Cable Size		Nominal Output Current	Motor Cable Size		Maximum Motor Cable Length	Recommended Brake Resistance Ω
			Non UL	UL	mm	AWG / kcmil		mm	AWG / kcmil		
0.37	0.5	11.0	16	15	2.5	14	2.3	1.5	14	100	N/A
0.75	1	19.0	25	25	4	10	4.3	1.5	14	100	N/A
1.1	1.5	25.0	32	35	6	8	5.8	1.5	14	100	50

200 - 240 Volt (+ / - 10%) 1 Phase Input, 3 Phase Output

kW	HP	Nominal Input Current	Fuse Or MCB (Type B)		Supply Cable Size		Nominal Output Current	Motor Cable Size		Maximum Motor Cable Length	Recommended Brake Resistance Ω
			Non UL	UL	mm	AWG / kcmil		mm	AWG / kcmil		
0.37	0.5	5.0	10	10	1.5	14	2.3	1.5	14	100	-
0.75	1	8.5	10	10	1.5	14	4.3	1.5	14	100	-
1.5	2	13.9	16	20	2.5	12	7	1.5	14	100	100
2.2	3	19.5	25	25	4	10	10.5	1.5	14	100	50

200 - 240 Volt (+ / - 10%) 3 Phase Input, 3 Phase Output

kW	HP	Nominal Input Current	Fuse Or MCB (Type B)		Supply Cable Size		Nominal Output Current	Motor Cable Size		Maximum Motor Cable Length	Recommended Brake Resistance Ω
			Non UL	UL (A)	mm	AWG / kcmil		mm	AWG / kcmil		
0.37	0.5	3.0	6	6	1.5	14	2.3	1.5	14	100	-
0.75	1	4.5	6	6	1.5	14	4.3	1.5	14	100	-
1.5	2	7.3	10	10	1.5	14	7	1.5	14	100	100
2.2	3	11.0	16	15	2.5	12	10.5	1.5	14	100	50
4	5	18.8	20	20	4	10	18	2.5	10	100	50

380 - 480 Volt (+ / - 10%) 3 Phase Input, 3 Phase Output

kW (400V)	HP (460V)	Nominal Input Current	Fuse Or MCB (Type B)		Supply Cable Size		Nominal Output Current	Motor Cable Size		Maximum Motor Cable Length	Recommended Brake Resistance Ω
			Non UL	UL (A)	mm	AWG / kcmil		mm	AWG / kcmil		
0.75	1	2.4	6	6	1.5	14	2.2	1.5	14	100	-
1.5	2	4.3	6	10	1.5	14	4.1	1.5	14	100	200
2.2	3	6.1	10	10	1.5	14	5.8	1.5	14	100	200
4	5	9.8	16	15	2.5	12	9.5	1.5	14	100	100
5.5	7.5	14.6	20	20	4	10	14	1.5	12	100	100
7.5	10	18.1	25	25	4	10	18	2.5	10	100	50
11	15	24.7	32	35	10	8	24	4	10	100	50

Note: For UL compliance, Motor Cable to be 75°C Copper, fuse current ratings in brackets (), UL Class T must be used.

9.3. Additional Information for UL Compliance

Optidrive E2 is designed to meet the UL requirements. In order to ensure full compliance, the following must be fully observed.

- For an up to date list of UL compliant products, please refer to UL listing NMMS.E226333
- The drive can be operated within an ambient temperature range as stated in section 9.1
- For IP20 units, installation is required in a pollution degree 1 environment
- For IP66 (Nema 4X) units, installation in a pollution degree 2 environment is permissible
- UL Listed ring terminals / lugs must be used for all bus bar and grounding connections

Input Power Supply Requirements				
Supply Voltage	200 – 240 RMS Volts for 230 Volt rated units, +/- 10% variation allowed. 240 Volt RMS Maximum			
	380 – 480 Volts for 400 Volt rated units, +/- 10% variation allowed, Maximum 500 Volts RMS			
Imbalance	Maximum 3% voltage variation between phase – phase voltages allowed			
	All Optidrive E2 units have phase imbalance monitoring. A phase imbalance of > 3% will result in the drive tripping. For input supplies which have supply imbalance greater than 3% (typically the Indian sub- continent & parts of Asia Pacific including China) Inverterk Drives recommends the installation of input line reactors.			
Frequency	50 – 60Hz +/- 5% Variation			
Short Circuit Capacity	Voltage Rating	Min kW (HP)	Max kW (HP)	Maximum supply short-circuit current
	115V	0.37 (0.5)	1.1 (1.5)	5kA rms (AC)
	230V	0.37 (0.5)	4 (5)	5kA rms (AC)
	400 / 460V	0.75 (1)	11 (15)	5kA rms (AC)
	All the drives in the above table are suitable for use on a circuit capable of delivering not more than the above specified maximum short-circuit Amperes symmetrical with the specified maximum supply voltage.			
Motor Cable	75°C Copper must be used			
Fusing	UL Class T Fuses must be used			
Incoming power supply connection must be according to section 4.3				
All Optidrive E2 units are intended for indoor installation within controlled environments which meet the condition limits shown in section 9.1				
Branch circuit protection must be installed according to the relevant national codes. Fuse ratings and types are shown in section 9.2				
Suitable Power and motor cables should be selected according to the data shown in section 9.2				
Power cable connections and tightening torques are shown in section 3.1				
Optidrive E2 provides motor overload protection in accordance with the National Electrical Code (US).				
<ul style="list-style-type: none"> • Where a motor thermistor is not fitted, or not utilised, Thermal Overload Memory Retention must be enabled by setting P-50 = 1 • Where a motor thermistor is fitted and connected to the drive, connection must be carried out according to the information shown in section 7.5 				

Information provided by
EMAG
 Tel: 01902 601403
 www.emag-ltd.co.uk

10. Trouble Shooting

10.1. Fault Code Messages

Drive Display Fault Code	Fault Number	Description	Corrective Action
StoP	0x00	Drive is healthy and in a stopped condition. The motor is not energised. No enable signal is present to start the drive	
P-dEF	0x0A	Factory Default parameters have been loaded	Press the STOP key, drive is ready to configure for particular application
O-I	0x03	Instantaneous Over current on the drive output. Excess load or shock load on the motor.	<p>Fault occurs immediately on drive enable or run command Check the output wiring connections to the motor and the motor for short circuits phase to phase and phase to earth.</p> <p>Fault occurs during motor starting Check the motor is free to rotate and there are no mechanical blockages. If the motor has a brake fitted, check the brake is releasing correctly. Check for the correct star-delta motor wiring. Ensure the motor nameplate current is correctly entered in P-08. Increase the acceleration time in P-03. Reduce the motor boost voltage setting in P-11</p> <p>Fault occurs when motor operating at constant speed Investigate overload or malfunction.</p> <p>Fault occurs during motor acceleration or deceleration The Accel/Decel times are too short requiring too much power. If P-03 or P-04 cannot be increased, a bigger drive may be required</p>
I.t-trP	0x04	Motor thermal overload protection trip. The drive has tripped after delivering >100% of value in P-08 for a period of time to prevent damage to the motor.	Ensure the correct motor nameplate current value is entered in P-08. Check for correct Star or Delta wiring configuration. Check to see when the decimal points are flashing (which indicates the output current > P-08 value) and either increase acceleration ramp (P-03) or decrease motor load. Check the total motor cable length is within the drive specification. Check the load mechanically to ensure it is free, and that no jams, blockages or other mechanical faults exist
Ol-b	0x01	Brake channel over current (excessive current in the brake resistor)	Check the cabling to the brake resistor and the brake resistor for short circuits or damage. Ensure the resistance of the brake resistor is equal to or greater than the minimum value for the relevant drive shown in the table in section 9.2
OL-br	0x02	Brake resistor thermal overload. The drive has tripped to prevent damage to the brake resistor	<p>Only occurs if P-34 = 1. The internal software protection for the brake resistor has activated to prevent damage to the brake resistor.</p> <p>If an Invertek standard braking resistor is being used, P-34 MUST be 1 Increase the deceleration time (P-04) or 2nd deceleration time (P-24). Reduce the load inertia</p> <p>For Other Brake Resistors Ensure the resistance of the brake resistor is equal to or greater than the minimum value for the relevant drive shown in the table in section 9.2. Use an external thermal protection device for the brake resistor. In this case, P-34 may be set to 2</p>
PS-trP	0x05	Hardware Over Current	Check the wiring to motor and the motor for phase to phase and phase to earth short circuits. Disconnect the motor and motor cable and retest. If the drive trips with no motor connected, it must be replaced and the system fully checked and retested before a replacement unit is installed.
U.Uo It	0x06	Over voltage on DC bus	Check the supply voltage is within the allowed tolerance for the drive. If the fault occurs on deceleration or stopping, increase the deceleration time in P-04 or install a suitable brake resistor and activate the dynamic braking function with P-34
U.Uo It	0x07	Under voltage on DC bus	The incoming supply voltage is too low. This trip occurs routinely when power is removed from the drive. If it occurs during running, check the incoming power supply voltage and all components in the power feed line to the drive.
O-t	0x08	Heatsink over temperature	The drive is too hot. Check the ambient temperature around the drive is within the drive specification. Ensure sufficient cooling air is free to circulate around the drive. Increase the panel ventilation if required. Ensure sufficient cooling air can enter the drive, and that the bottom entry and top exit vents are not blocked or obstructed.
U-t	0x09	Under temperature	Trip occurs when ambient temperature is less than -10°C. Temperature must be raised over -10°C in order to start the drive.
th-FLt	0x10	Faulty thermistor on heatsink.	Refer to your IDL Authorised Distributor.
E-tr iP	0x0B	External trip (on digital Input 3)	E-trip requested on digital input 3. Normally closed contact has opened for some reason. If motor thermistor is connected check if the motor is too hot.
SC-trP	0x0C	Comms loss trip	Check communication link between drive and external devices. Make sure each drive in the network has its unique address.
P-LOSS	0x0E	Input phase loss trip	Drive intended for use with a 3 phase supply has lost one input phase.
SPI n-F	0x0F	Spin start failed	Spin start function failed to detect the motor speed.
dRA-F	0x11	Internal memory fault.	Parameters not saved, defaults reloaded. Try again. If problem recurs, refer to your IDL Authorised Distributor.
4-20 F	0x12	Analog input current out of range	Check input current in range defined by P-16.
SC-FLt	-	Internal drive Fault	Refer to your IDL Authorised Distributor.
FAULTY	-	Internal drive Fault	Refer to your IDL Authorised Distributor.



82-E2MAN-IN_V3.10